

# AURORA

TOOLS

Celebrating  
**15**  
YEARS



# AURORA

## TOOLS

## ABOUT US

### Mission

Our mission at Aurora Tools is to equip the Canadian industrial market with high-quality products at an affordable price.

### Vision

Our aim is to put the right tool in your hands to tackle any task. We offer a wide range of reliable tools and accessories that belong in every Canadian's toolbox. We want to be the trusted partner you turn to for all your projects.

### Values

At Aurora Tools, we focus on affordability without compromising performance. We are driven by our commitment to continuous improvement and delivering unmatched value and reliability to our customers.

### Story

Our journey started 15 years ago, with a goal to provide affordable, reliable tools to the Canadian market. What began with bench vises has now expanded to include a diverse range of tools and accessories across 190 categories. Today, we search the globe to expand our product offering, empowering our customers to choose value and quality they can depend on for every job.



**Retail Packaging Available:** Look throughout the catalogue for this symbol indicating that Retail Packaging is available.

# HAND TOOLS

Indestructible Hammers.....	2	Pipe Wrenches .....	16, 17
Hammers & Mallets .....	3	Hacksaw, Bars & Bolt Cutters .....	18
Hammer Sets.....	4	Snips, Caulking Guns & Drill Bit Set ....	19
Hammer Set & Stamp Set .....	5	Hand Files & Sets .....	20
Pliers.....	6	Punches, Chisels & Sets.....	21, 22, 23
Plier Sets .....	7	1/4" Drive Socket Accessories .....	24
Locking Pliers .....	8	1/4" Drive Sockets .....	25
Locking Pliers Sets .....	9	3/8" Drive Socket Accessories .....	26
Combined Plier Sets.....	10	3/8" Drive Sockets .....	27
Screwdrivers .....	11	1/2" Drive Socket Accessories .....	28
Screwdriver Sets .....	12	1/2" Drive Sockets .....	29
Insulated Tool Set and Hex Key Sets....	13	Socket Sets .....	30, 31, 32, 33
Combination Wrenches & Sets .....	14	Measuring Instruments .....	34
Ratchet Wrenches & Sets .....	15	Measuring Tapes .....	35
Adjustable Wrenches & Sets.....	16	Levels .....	36

# INDESTRUCTIBLE HANDLE HAMMERS

- Indestructible handle is made with spring steel bars, encased in rubber, running through the handle
- Spring steel bars are locked into the hammer head with steel locking plates, ensuring it never dislodges
- Ergonomic rubber grip handle absorbs impact and vibration reducing user fatigue
- Will not break, bend, or split even after repeated overstrikes
- Head is induction case hardened 52-56 HRC
- Meets ANSI BS 876 standard for material hardness and performance

Model No.	Head Weight lbs.	No. of Spring Steel Bars	Handle Length"
<b>CLUB HAMMERS</b>			
TYB492	4	4	12
TYB493	4	4	16
<b>SLEDGE HAMMERS</b>			
TYB494	6	6	24
TYB495	8	6	24
TYB496	8	6	30
TYB497	10	6	30
TYB498	12	6	30
TYB499	14	6	30

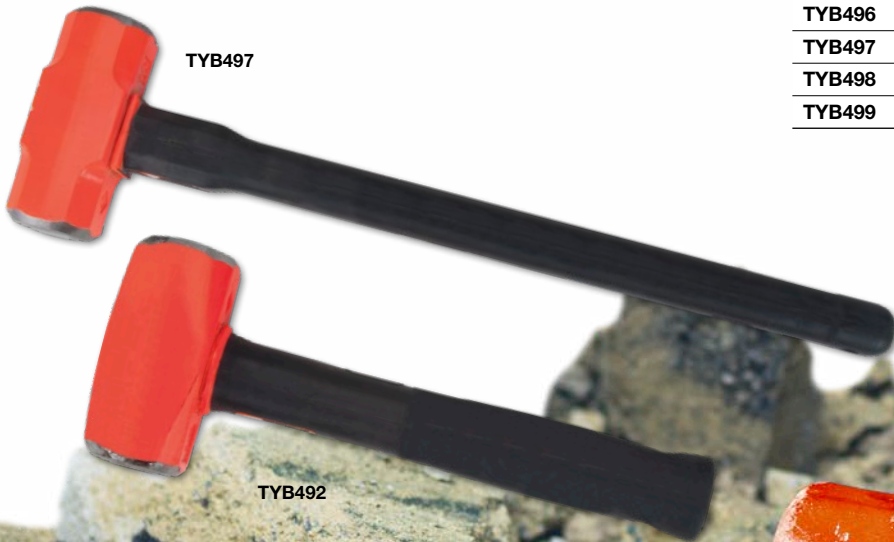

## TUBULAR HANDLE HAMMER

- 1.4 mm hardened tubular steel shaft
- Fully polished heat-treated face with octagonal neck
- Shock-absorbing cushion grip handle
- Steel overstrike ring
- Meets ANSI standards

Model No.	Type	Head Weight oz.
TJZ032	Claw	16



## HICKORY HANDLE HAMMERS

- Large natural colour, American hickory handle
- Extra tough, heat-treated fully polished head
- Extra large striking face
- Natural shock absorbing qualities of natural wood
- Meets ANSI standards

Model No.	Type	Head Weight oz.
TJZ033	Claw	16
TJZ034	Framing	22



## DEAD BLOW HAMMERS

- 1-piece urethane construction
- Completely enclosed steel shank
- Shot-filled head
- High visibility orange colour

Model No.	Head Weight oz.
TJZ035	8
TJZ036	16
TJZ037	24
TJZ038	32



## BALL PEIN HAMMERS

- Kiln-dried hickory handle
- High quality construction
- Natural shock-absorbing qualities of natural wood
- Meets ANSI standards

Model No.	Head Weight oz.
TJZ039	8
TJZ040	16
TJZ041	24
TJZ042	32



## RUBBER MALLETS

- Hardwood handle
- Non-marking white rubber head (TJZ045 and TJZ046)

Model No.	Head Weight oz.	Colour
TJZ043	16	Black
TJZ044	32	Black
TJZ045	16	White
TJZ046	32	White



## 2-PIECE HICKORY HANDLE HAMMER SET

- Large natural colour, American hickory handle
- Extra tough, heat-treated fully polished head
- Extra large striking face
- Natural shock absorbing qualities of natural wood
- Meets ANSI standards

### SET INCLUDES

- TJZ033** Hickory Handle, Claw Hammer, 16 oz.  
**TJZ034** Hickory Handle, Framing Hammer, 22 oz.

Model No. TLV114



## 4-PIECE DEAD BLOW HAMMER SET

- One piece urethane construction
- Completely enclosed steel shank
- Shot-filled head
- High visibility orange colour

### SET INCLUDES:

- TJZ035** Dead Blow Hammer, 8 oz.  
**TJZ036** Dead Blow Hammer, 16 oz.  
**TJZ037** Dead Blow Hammer, 24 oz.  
**TJZ038** Dead Blow Hammer, 32 oz.

Model No. TLV113



## 4-PIECE BALL PEIN HAMMER SET

- Kiln-dried hickory handle
- High quality construction
- Natural shock-absorbing qualities of natural wood
- Meets ANSI standards

### SET INCLUDES:

- TJZ039** Ball Pein Hammer 8 oz.  
**TJZ040** Ball Pein Hammer, 16 oz.  
**TJZ041** Ball Pein Hammer, 24 oz.  
**TJZ042** Ball Pein Hammer, 32 oz.

Model No. TLV112



## 4-PIECE RUBBER MALLET SET

- Hardwood handle
- Non-marking white rubber head (**TJZ045** and **TJZ046**)

### SET INCLUDES:

- TJZ043** Mallet, Black, 16 oz.  
**TJZ044** Mallet, Black, 32 oz.  
**TJZ045** Mallet, White, 16 oz.  
**TJZ046** Mallet, White, 32 oz.

Model No. TLV115



## 8-PIECE UNIVERSAL HAMMER SET

- The most popular striking tools for a wide variety of applications

### SET INCLUDES:

- TJZ032** Claw Hammer, Tubular Handle, 16 oz.
- TJZ034** Framing Hammer, Hickory Handle, 22 oz.
- TJZ036** Dead Blow Hammer, 16 oz.
- TJZ038** Dead Blow Hammer, 32 oz.
- TJZ040** Ball Pein Hammer, 16 oz.
- TJZ042** Ball Pein Hammer, 32 oz.
- TJZ044** Mallet, Black, 32 oz.
- TJZ045** Mallet, White, 16 oz.

Model No. TLV116



## 15-PIECE ULTIMATE HAMMER SET

- The most comprehensive hammer set on the market
- Includes a hammer for virtually every application

### SET INCLUDES:

- TJZ032** Claw Hammer, Tubular Handle, 16 oz.
- TJZ033** Claw Hammer, Hickory Handle, 16 oz.
- TJZ034** Framing Hammer, Hickory Handle, 22 oz.
- TJZ035** Dead Blow Hammer, 8 oz.
- TJZ036** Dead Blow Hammer, 16 oz.
- TJZ037** Dead Blow Hammer, 24 oz.
- TJZ038** Dead Blow Hammer, 32 oz.
- TJZ039** Ball Pein Hammer, 8 oz.
- TJZ040** Ball Pein Hammer, 16 oz.
- TJZ041** Ball Pein Hammer, 24 oz.
- TJZ042** Ball Pein Hammer, 32 oz.
- TJZ043** Mallet, Black, 16 oz.
- TJZ044** Mallet, Black, 32 oz.
- TJZ045** Mallet, White, 16 oz.
- TJZ046** Mallet, White, 32 oz.

Model No. TLV117



## STAMP SETS

- For hand held, hammer struck applications
- Manufactured from high quality steel
- Induction hardened for added durability and extended life
- Beveled striking edge prevents breakage and accidents during use
- Stamping end is hardened at 58-62 HRC and the striking end is hardened to 38-43 HRC to prevent splintering
- Letter sets contain 27 pieces, "A" through "Z" and "&"- (ampersand)
- Number sets contain 9 pieces, "0" through "9", numbers "6" and "9" are interchangeable

Model No.	Character Size"	Type
TLZ389	1/8	Number
TLZ390	3/16	Number
TLZ391	1/4	Number
TLZ392	1/8	Letter
TLZ393	3/16	Letter
TLZ394	1/4	Letter



### INDUSTRIAL MULTI-TOOL

- Stainless steel components
- Anodized aluminum body with ABS inlays provides premium comfort
- Heavy-duty nylon pouch
- Self locking components for safe use
- Gun metal finish
- Overall length: 6.25"
- Closed length: 4"
- Weight: 9.3 oz.



**INCLUDES:** Flat-nose pliers, wire cutter, fine edge knife, Phillips screwdriver, bottle opener, small and medium flat screwdriver, metal/wood file, double tooth saw, serrated knife, can opener

**Model No. TLZ463**

### GROOVE JOINT PLIERS

- Sure gripping precision milled jaws
- Grooves undercut and milled to prevent slipping when tightening
- Light and rugged drop-forged alloy steel
- Flush pivot design for use in tight spaces
- Meets ANSI standards



Model No.	Length"
UAV656	8
UAV657	10

### DIAGONAL CUTTING PLIERS

- Precision tested jaws provide uniform cut
- Slim profile reaches into cramped quarters
- Nickel plated finish resists corrosion and rust
- Induction heat-treated cutting edge
- Smooth non-sticking lever mechanism
- Meets ANSI standards



Model No.	Length"
UAV658	6
UAV659	7.5

### LONG NOSE CUTTING PLIERS

- Strong sure gripping jaws manipulate wire and other awkward objects
- Slim tapered head extends reach and maintains visibility in small areas
- Nickel plated finish resists corrosion and rust
- Meets ANSI standards



Model No.	Length"
UAV660	6
UAV661	8

### LINESMAN CUTTING PLIERS

- Precision milled jaw grip and hold wire without slipping
- Nickel plated finish resists corrosion and rusts
- Meets ANSI standards



Model No.	Length"
UAV662	7
UAV663	8

### SLIP JOINT PLIERS

- Sure gripping precision milled jaws
- Light and rugged drop-forged alloy steel
- Flush pivot design for use in tight spaces
- Meets ANSI standards



Model No.	Length"
UAV655	6



## ▶ 3-PIECE BASIC PLIER SET

- Precision milled jaws
- Nickel plated finish resists corrosion and rust
- Meets ANSI standards

### SET INCLUDES:

- UAV655** Slip Joint, 6" L
- UAV658** Diagonal Cutting, 6" L
- UAV660** Long Nose Cutting, 6" L

Model No. UAV790



## ▶ 9-PIECE ALL-PURPOSE PLIER SET

- Precision milled jaws wire without slipping
- Nickel plated finish resists corrosion and rust
- Meets ANSI standards

### SET INCLUDES:

- UAV655** Slip Joint, 6" L
- UAV656** Groove Joint, 8" L
- UAV657** Groove Joint, 10" L
- UAV658** Diagonal Cutting, 6" L
- UAV659** Diagonal Cutting, 7.5" L
- UAV660** Long Nose Cutting, 6" L
- UAV661** Long Nose Cutting, 8" L
- UAV662** Linesman Cutting, 7" L
- UAV663** Linesman Cutting, 8" L

Model No. UAV791



## CURVED JAW PLIERS WITH WIRE CUTTING

Model No.	Length"
UAV664	5
UAV665	7
UAV666	10



- Tempered chrome vanadium steel jaws
  - Hardened tension bar with toggle mechanism provides secure locking action
  - Smooth screw adjustment for easy and rapid setting
  - Meets ANSI standards

## LONG NOSE PLIERS WITH WIRE CUTTING

Model No.	Length"
UAV667	6.5



## C-CLAMP PLIERS

Model No.	Length"
TJZ096	6
UAV668	11

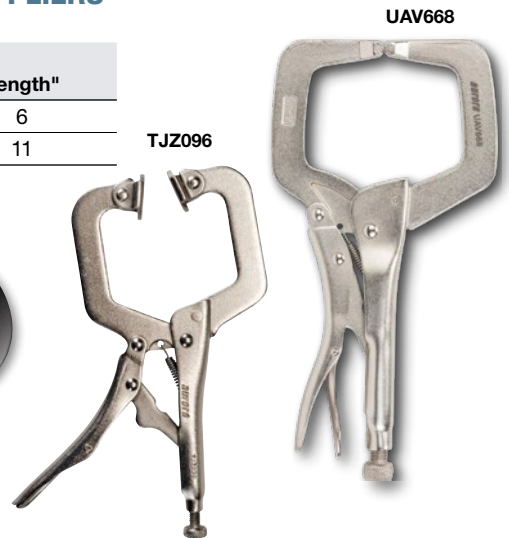

## LOCKING WELDING CLAMP PLIERS

Model No.	Grip	Length"
TJZ098	Steel	9



## LOCKING SHEET METAL TOOL PLIERS

Model No.	Grip	Length"
TJZ099	Steel	8



## 3-PIECE CURVED JAW LOCKING PLIERS W/WIRE CUTTER SET

- Tempered chrome vanadium steel jaws
- Hardened tension bar with toggle mechanism provides secure locking action
- Smooth screw adjustment for easy and rapid setting
- Meets ANSI standards

### SET INCLUDES:

- UAV664** Curved Jaw w/ Wire Cutter, 5" L
- UAV665** Curved Jaw w/ Wire Cutter, 7" L
- UAV666** Curved Jaw w/ Wire Cutter, 10" L

Model No. **UAV792**



## 6-PIECE LOCKING PLIER SET

- Tempered chrome vanadium steel jaws
- Hardened tension bar with toggle mechanism provides secure locking action
- Smooth screw adjustment for easy and rapid setting
- Meets ANSI standards

### SET INCLUDES:

- UAV664** Curved Jaw w/ Wire Cutter, 5" L
- UAV665** Curved Jaw w/ Wire Cutter, 7" L
- UAV666** Curved Jaw w/ Wire Cutter, 10" L
- UAV667** Long Nose w/ Wire Cutter, 6.5" L
- TJZ096** C-clamps w/ Swivel Pads, 6" L
- UAV668** C-clamps 11" L

Model No. **TLZ792**



## 4-PIECE WELDING CLAMP SET

### SET INCLUDES:

- TJZ096** C-Clamp with Swivel Pad, 6"
- UAV668** C-Clamp 11"
- TJZ998** Locking Welding Clamp, 9"
- TJZ099** Locking Sheet Metal Tool, 8"

Model No. **TLV133**



## ▶ 15-PIECE ALL PURPOSE PLIER SET

### PLIERS:

- Precision milled jaws
- Nickel plated finish resists corrosion and rust
- Meets ANSI standards

### LOCKING PLIERS:

- Tempered chrome vanadium steel jaws
- Hardened tension bar with toggle mechanism provides secure locking action
- Smooth screw adjustment for easy and rapid setting
- Meets ANSI standards

### SET INCLUDES:

#### PLIERS, NICKEL PLATED FINISH:

- UAV655** Slip Joint, 6" L
- UAV656** Groove Joint, 8" L
- UAV657** Groove Joint, 10" L
- UAV658** Diagonal Cutting, 6" L
- UAV659** Diagonal Cutting, 7.5" L
- UAV660** Long Nose Cutting, 6" L
- UAV661** Long Nose Cutting, 8" L

#### LOCKING PLIERS:

- UAV662** Linesman Cutting, 7" L
- UAV663** Linesman Cutting, 8" L
- UAV664** Curved Jaw w/ Wire Cutter, 5" L
- UAV665** Curved Jaw w/ Wire Cutter, 7" L
- UAV666** Curved Jaw w/ Wire Cutter, 10" L
- UAV667** Long Nose w/ Wire Cutter, 6.5" L
- TJZ096** C-clamps w/ Swivel Pads, 6" L
- UAV668** C-clamps 11" L

Model No. UAV794

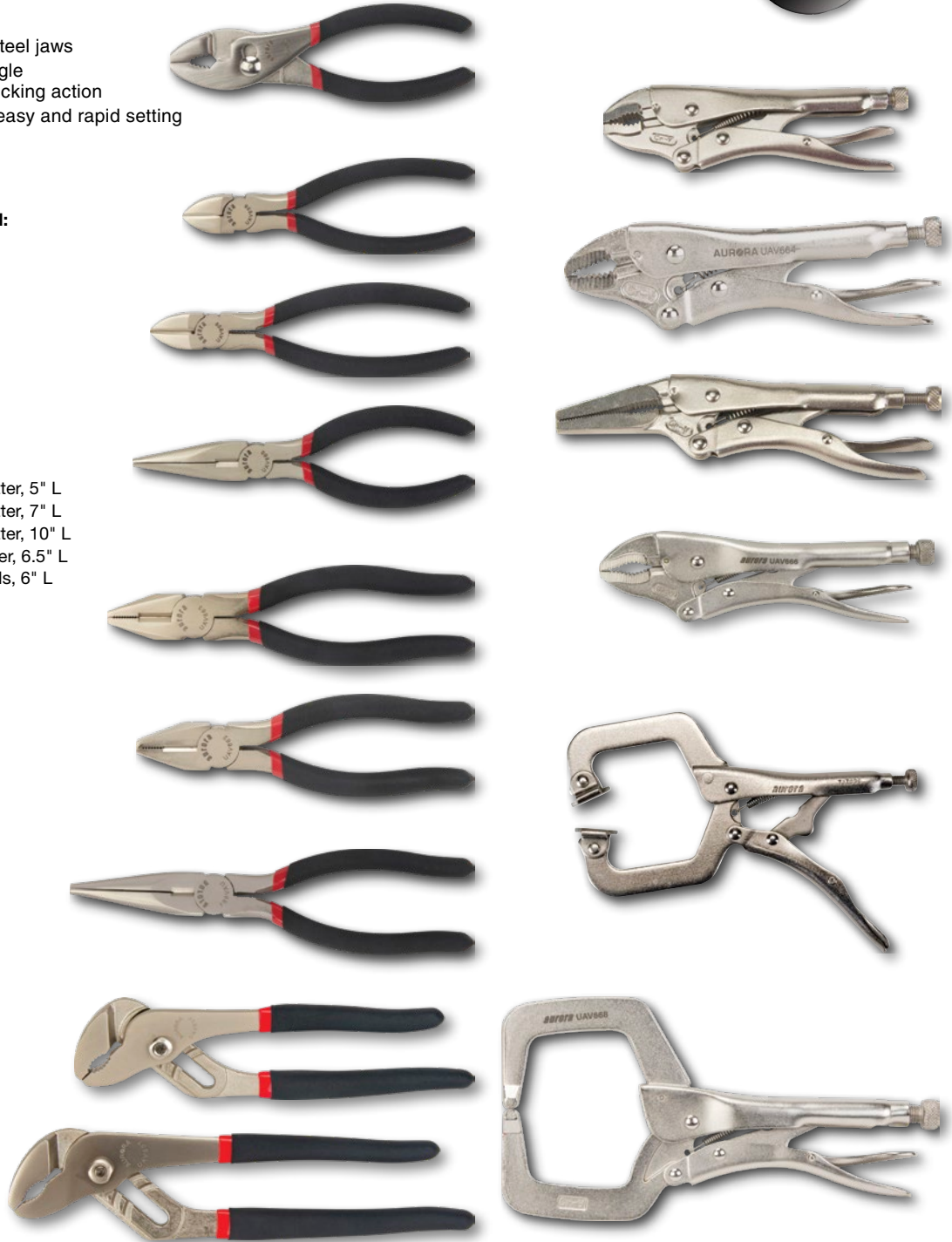



Screwdriver type indication on the base of the grip



- Industrial quality and strength
- Chrome vanadium steel blade
- Treated blade tip for a lifetime of performance
- Extra large ergonomic handle for maximum torque and comfort
- Colour-coded handle for square tip type
- Meets ANSI standards



Slot Electrician

Model No.	Tip Width"	Shank Length"
<b>● SLOT ELECTRICIANS</b>		
TJZ057	1/8	3
TJZ058	3/16	4
TJZ059	3/16	6



Slot Mechanics

<b>● SLOT MECHANICS</b>		
TJZ060	1/4	1-1/2 Stubby
TJZ061	1/4	4
TJZ062	1/4	5
TJZ063	1/4	6
TJZ064	5/16	6
TJZ065	3/8	8

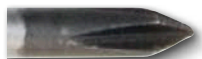

Phillips Tip

<b>⊕ PHILLIPS TIP</b>		
TJZ066	#0	2-1/2
TJZ067	#1	3-1/4
TJZ068	#2	4
TJZ069	#2	1-1/2 Stubby
TJZ070	#3	6



Square Tip

<b>□ SQUARE TIP</b>		
TJZ071	#0	4
TJZ072	#1	4
TJZ075	#1	1-1/2 Stubby
TJZ073	#2	6
TJZ076	#2	1-1/2 Stubby
TJZ074	#3	6
TJZ077	#3	1-1/2 Stubby



- Industrial quality and strength
- Treated blade tip for a lifetime of performance
- Meets ANSI standards



Model No.	Description	Contents
TJZ826	3-Piece Set	<b>Square Tip:</b> #1, #2, #3
TJZ827	7-Piece Set	<b>Square Tip:</b> #1, #2 <b>Phillips:</b> #1, #2 <b>Flat:</b> 1/8", 1/4", 5/16"
TJZ828	16-Piece Set	<b>Square Tip:</b> #0, #1, #2, #3, #2 Stubby <b>Phillips:</b> #0, #1, #2, #3, #2 Stubby <b>Flat:</b> 1/8", 3/16", 1/4", 5/16", 3/8", 1/4" Stubby

## INSULATED TOOL SET

- Meets the VDE insulated quality standard
- Leather carry case conveniently stores and protects tools
- Voltage Rating: 1000 V
- No. of Pieces: 10

### SET INCLUDES:

- VDE Slotted Screwdriver, 7/32" x 5" L
- VDE Slotted Screwdriver, 5/32" x 4" L
- VDE Slotted Screwdriver, 3/32" x 3" L
- VDE Phillips® Screwdriver, #1 x 3-1/8" L
- VDE Phillips® Screwdriver, #2 x 4" L
- VDE Pozidriv® Screwdriver, #1 x 3-1/8" L
- VDE Pozidriv® Screwdriver, #2 x 4" L
- VDE Lineman Pliers, 6" L
- VDE Long Nose Pliers, 6" L
- VDE Side Cutting Pliers, 6" L

Model No. TYP305



## HEX KEY POUCH SETS

- Chrome vanadium steel for strength and durability
- Tips are chamfered for ease of entry and proper fit



TNB731



TNB732

Model No.	No. of Keys	Key Sizes
<b>S.A.E. - SHORT ARM</b>		
TNB731	13	1/20", 1/16", 5/64", 3/32", 7/64", 1/8", 9/64", 5/32", 3/16", 7/32", 1/4", 5/16", 3/8"
<b>METRIC - SHORT ARM</b>		
TNB732	9	1.5 mm, 2.0 mm, 2.5 mm, 3.0 mm, 4.0 mm, 5.0 mm, 6.0 mm, 8.0 mm, 10.0 mm

## FOLDING HEX KEY SETS

- Chrome vanadium steel for strength and durability
- Tips are chamfered for ease of entry and proper fit
- Set folds securely into convenient storage compartment

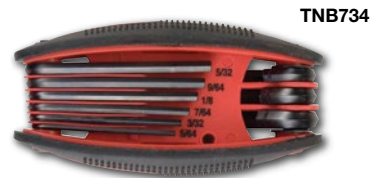

TNB734



TNB733

Model No.	No. of Keys	Key Sizes
<b>S.A.E. FOLD UP</b>		
TNB733	9	5/64", 3/32", 7/64", 1/8", 9/64", 5/32", 3/16", 7/32", 1/4"
<b>METRIC FOLD UP</b>		
TNB734	8	1.5 mm, 2.0 mm, 2.5 mm, 3.0 mm, 4.0 mm, 5.0 mm, 6.0 mm, 8.0 mm
<b>S.A.E. - BALL END FOLD UP</b>		
TNB735	9	5/64", 3/32", 7/64", 1/8", 9/64", 5/32", 3/16", 7/32", 1/4"

## COMBINATION WRENCHES

- Chrome vanadium steel for strength and durability
- Heat treated for consistent hardness
- Precision broached jaws for sure gripping
- 12-point box end for snug fit
- Thin walled construction for access in cramped quarters
- Meets ANSI standards



Model No.	Size"	Length"
<b>S.A.E.</b>		
TYK599	1/4	3-7/8
TYK600	5/16	4-3/4
TYK601	11/32	4-1/4
TYK602	3/8	5-3/8
TYK603	7/16	6
TYK604	1/2	6-3/4
TYK605	9/16	7
TYK606	5/8	8
TYK607	11/16	8-11/16
TYK608	3/4	9
TYK609	13/16	9-5/8
TYK610	7/8	10-1/4
TYK611	15/16	10-7/8
TYK612	1	11-1/8
TYK613	1 1/16	12
TYK614	1 1/8	12-1/2
TYK615	1 1/4	14

Model No.	Size mm	Length mm
<b>METRIC</b>		
TYK616	6	98
TYK617	7	108
TYK618	8	131
TYK619	9	130
TYK620	10	151
TYK621	11	149
TYK622	12	161
TYK623	13	171
TYK624	14	181
TYK625	15	191
TYK626	16	197
TYK627	17	211
TYK628	18	216
TYK629	19	231
TYK630	20	238
TYK631	21	252
TYK632	22	257
TYK633	23	267
TYK634	24	292
TYK635	25	300
TYK636	26	292
TYK637	27	305
TYK638	28	323
TYK639	29	345
TYK640	30	337
TYK641	32	373

## COMBINATION WRENCH SETS

TLV053



TLV055



Model No.	Description
TLV053	<b>11 S.A.E. Combination Wrenches:</b> 1/4", 5/16", 3/8", 7/16", 1/2", 9/16", 5/8", 11/16", 3/4", 13/16", 7/8"
TLV054	<b>11 Metric Combination Wrenches:</b> 7 mm, 8 mm, 9 mm, 10 mm, 11 mm, 12 mm, 13 mm, 14 mm, 15 mm, 17 mm, 19 mm
TLV055	<b>14 S.A.E. Combination Wrenches:</b> 3/8", 7/16", 1/2", 9/16", 5/8", 11/16", 3/4", 13/16", 7/8", 15/16", 1", 1-1/16", 1-1/8", 1-1/4"
TLV056	<b>14 Metric Combination Wrenches:</b> 10 mm, 12 mm, 13 mm, 14 mm, 15 mm, 16 mm, 17 mm, 18 mm, 19 mm, 22 mm, 24 mm, 27 mm, 30 mm, 32 mm



## RATCHETING COMBINATION WRENCHES

- Chrome vanadium steel for strength and durability
- Ratcheting head allows for faster removal and installation of fasteners
- 72-tooth ratchet gear
- 12-point box end for snug fit
- Needs as little as 5 Degrees to move a fastener
- Meets ANSI standards

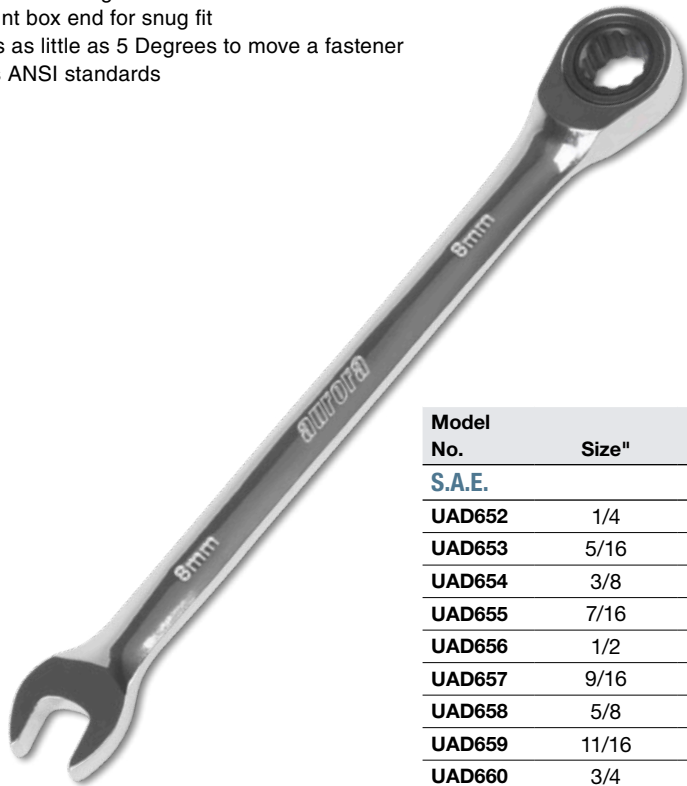

Model No.	Size"	Length"
<b>S.A.E.</b>		
UAD652	1/4	5-1/4
UAD653	5/16	5-1/4
UAD654	3/8	6-1/4
UAD655	7/16	6-1/2
UAD656	1/2	7
UAD657	9/16	7-7/16
UAD658	5/8	8-1/16
UAD659	11/16	8-13/16
UAD660	3/4	9-11/16
UAD661	13/16	11
UAD662	7/8	11
UAD663	15/16	12-3/16
UAD664	1"	12-3/16

Model No.	Size mm	Length mm
<b>METRIC</b>		
UAD665	7	134
UAD635	8	134
UAD636	9	158.5
UAD637	10	158.5
UAD638	11	164.6
UAD639	12	167.7
UAD640	13	177.4
UAD641	14	189.5
UAD642	15	198
UAD643	16	205.4
UAD644	17	224
UAD645	18	235.4
UAD646	19	246.4

## RATCHETING WRENCH SETS



Model No.	Description
TEQ832	<b>8 S.A.E. Combination Wrenches:</b> 5/16", 3/8", 7/16", 1/2", 9/16", 5/8", 11/16", 3/4"
TEQ833	<b>13 S.A.E. Combination Wrenches:</b> 1/4", 5/16", 3/8", 7/16", 1/2", 9/16", 5/8", 11/16", 3/4", 13/16", 7/8", 15/16", 1"
TEQ834	<b>8 Metric Combination Wrenches:</b> 8 mm, 10 mm, 12 mm, 13 mm, 14 mm, 15 mm, 16 mm, 18 mm
TEQ835	<b>13 Metric Combination Wrenches:</b> 7 mm, 8 mm, 9 mm, 10 mm, 11 mm, 12 mm, 13 mm, 14 mm, 15 mm, 16 mm, 17 mm, 18 mm, 19 mm

## ▶ ADJUSTABLE WRENCHES

- Superior grade chrome vanadium steel
- Precision machined jaws
- Slim profile head slips into cramped quarters
- Tight tolerances ensure close fitting, wobble-free action
- Smooth, non-sticking mechanism
- Black nickel finish resists rust
- Meets ANSI standards



Model No.	L"	Max. Jaw Width"	Description
TJZ100	6	1	Standard Jaw, Composite Body
TJZ101	8	1-1/4	Reversible Jaw, Composite Body
TJZ102	10	1-3/8	Reversible Jaw, Composite Body
TJZ103	12	1-5/8	Reversible Jaw, Composite Body
TJZ104	15	1-3/4	Standard Jaw, Steel Body
TJZ105	18	2-1/4	Standard Jaw, Steel Body

## ▶ 6-PIECE ADJUSTABLE WRENCH SET

SET INCLUDES: TJZ100, TJZ101, TJZ102, TJZ103, TJZ104 & TJZ105

Model No. TLZ796  
255.00



## ▶ PIPE WRENCHES

- Drop-forged alloy steel jaw
- Durable ductile steel body provides the ultimate in performance
- Precision milled sure gripping teeth
- Spring action ensures sure grip and quick release

Model No.	Length"	Pipe Capacity"
TJZ106	8	1
TJZ107	10	1-1/2
TJZ108	12	2
TJZ109	14	2
TJZ110	18	2-1/2
UAL050	24	3
UAL051	36	5
UAL052	48	6



# ALUMINUM PIPE WRENCHES

- Drop-forged alloy steel jaw
- Lightweight for less user fatigue and ideal for overhead pipe work
- Precision milled sure gripping teeth
- Spring action ensures sure grip and quick release
- Handle Material: Aluminum
- Handle Type: Ergonomic
- Finish: Plain

Model No.	Length"	Jaw Capacity"
UAL053	10	1-1/2
UAL054	12	2
UAL055	14	2
UAL056	18	2-1/2
UAL057	24	3
UAL058	36	5
UAL059	48	6



## HACKSAW

- Heavy 16-gauge round steel tubing
- Comfort and guarded grip handle
- Blade Length: 12"
- Depth of Bow: 4"
- Tensile Strength: 8000 PSI

Model No. TYW991



## ACTION BAR

- High quality heat-treated carbon steel
- Edges are specially bevelled for pulling, lifting and scraping
- Baked paint finish
- 13-1/2" L x 1-3/8" W
- Colour: Black

Model No. TJZ047



## WRECKING BAR

- High quality steel
- Width: 7/8"
- Overall Length: 14"
- Colour: Black

Model No. TYL028



## BOLT CUTTERS

- Chrome molybdenum steel jaws
- Centre cutting blades
- Adjusting screws allow for easy and perfect alignment of jaws
- Strong tubular handle with slip-proof rubber grips

Model No.	Length"	Max. Jaw Opening"
TJZ111	14	1/4
TJZ112	18	5/16
TJZ113	24	3/8
TJZ114	36	9/16



TJZ112



## GOOSENECK WRECKING BARS

- High quality steel
- Hexagon shank
- Bevelled edges for pulling and lifting

Model No.	Diameter"	Length"	Weight lbs.
TJZ048	5/8	18	1.9
TJZ049	3/4	24	3.5
TJZ050	3/4	30	4.4
TJZ051	3/4	36	5



TJZ048



## ▶ COMPOUND SNIPS

- Designed for all-purpose cutting applications, for home or professional jobsite
- Cuts straight, left or right in light stock
- Latch secures blades for storage
- Rubberized hand grip for quality comfort
- Cutting Capacity: 18-Gauge Steel
- Overall Length: 10-1/4"



UAE006

Model No.	Colour	Cut Length"	Cutting Direction
UAE006	Red	1-3/8	Left Cut
UAE007	Green	1-1/8	Right Cut
UAE008	Yellow	1-1/2	Straight Cut

## ▶ CAULKING GUNS

- Compact size to fit in a tool box
- Comfortable operation
- Smooth application



UAE002

Model No.	Description	Cartridge Capacity
TTY156	Standard	300 ml
UAE002	Ratchet Style	300 ml

## ▶ JOBBER LENGTH DRILL BIT SET

- Industrial duty 29 piece drill bit set
- For use on steels, cast iron and most non-ferrous metals
- Round shank
- Two tone black oxide finish provides ideal chip flow and resistance to abrasion
- Steel case included



Model No. TCT047



## HAND FILES

- All models are also available with a handle for easy use

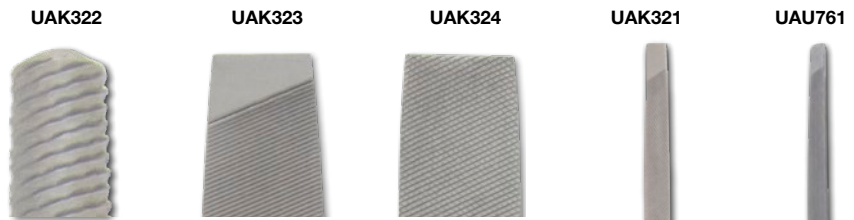

Model No.	Shape	L"	Cut Type
<b>WITH HANDLE</b>			
UAU761	Slim	6	Single
UAU762	Round	6	Second
UAU763	Mill	6	Bastard
UAU766	Mill	8	Bastard
UAU765	Mill	10	Bastard
UAU768	Mill	12	Bastard
UAU767	Mill	8	Smooth
UAU772	Half Round	8	Bastard
UAU764	Half Round	10	Bastard
UAU770	Round	10	Bastard
UAU771	Flat	8	Bastard
UAU769	Flat	10	Bastard

Model No.	Shape	L"	Cut Type
<b>NO HANDLE</b>			
UAK321	Slim	6	Single
UAK322	Round	6	Second
UAK323	Mill	6	Bastard
UAK326	Mill	8	Bastard
UAK325	Mill	10	Bastard
UAK328	Mill	12	Bastard
UAK327	Mill	8	Smooth
UAK332	Half Round	8	Bastard
UAK324	Half Round	10	Bastard
UAK330	Round	10	Bastard
UAK331	Flat	8	Bastard
UAK329	Flat	10	Bastard
UAK333	Half Round	6	Multiple



## FILE SETS

- General purpose file kits suitable for home and professional use
- Suitable for use on metals, mild steel, iron, plastics, stainless steel, hard rubber, and wood

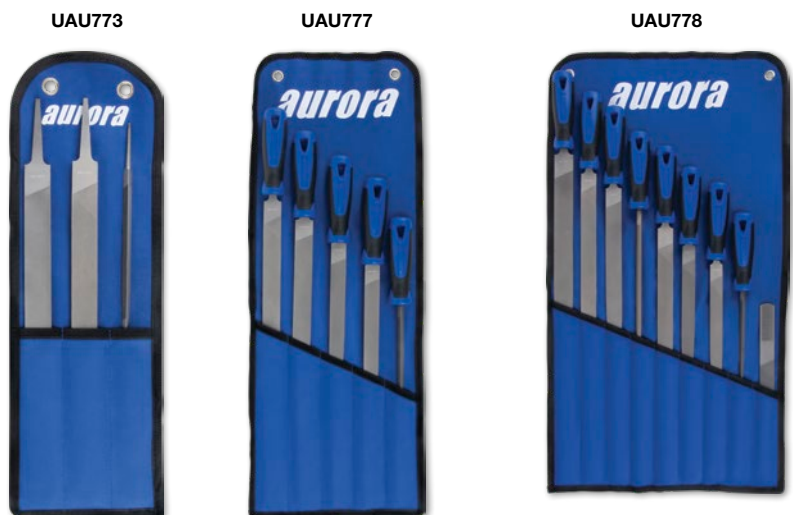

Model No.	Description	Includes
UAU773	3-piece Kit	6" Slim taper file, 10" Mill bastard file, 10" Half round bastard file
UAU776	3-piece Kit with Handles	
UAU774	5-piece Kit	6" Slim taper file, 8" Mill bastard file, 8" Smooth mill file, 10" Mill bastard file, 10" Half round bastard file
UAU777	5-piece Kit with Handles	
UAU775	9-piece Kit	6" Slim taper file, 8" Flat bastard file, 8" Half round bastard file, 10" Mill bastard file, 10" Flat bastard file, 10" Half round bastard file, 10" Round bastard file, 12" Mill bastard file, 4-in-1 Rasp & file combination
UAU778	9-piece Kit with Handles	

## COLD CHISELS

- Individually forged from high quality alloy steel
- Manufactured to the highest safety standards
- Precisely ground cutting edge is induction hardened to 52-58 HRC
- Striking head is hardened to 42 HRC to prevent splintering during use



Model No.	Cut Width"	Stock Size"	Overall Length"
TLZ395	1/4	1/4	5
TLZ396	5/16	1/4	5
TLZ397	3/8	5/16	5-1/2
TLZ398	1/2	7/16	6
TLZ399	5/8	1/2	6-1/2
TLZ400	3/4	5/8	7
TLZ556	7/8	3/4	7-1/2



TLZ395

### 6-PC. COLD CHISEL SET

Model No. TLZ420

SET INCLUDES SIZES:  
1/4", 5/16", 3/8", 1/2", 5/8", & 3/4"



## PIN PUNCHES

- Ideal for driving out and removing already loosened pins and keys after initial movement by a starting punch
- Manufactured from high quality carbon steel
- Single piece construction with hexagonal shank increases durability
- Accurately hardened for increased service life



Model No.	Point Diameter"	Stock Size"	Overall Length"
TLZ401	1/16	1/4	4
TLZ402	3/32	5/16	4-1/2
TLZ403	1/8	5/16	4-3/4
TLZ404	5/32	5/16	5
TLZ405	3/16	5/16	5-1/4
TLZ555	7/32	3/8	5-1/2
TLZ406	1/4	3/8	5-3/4
TLZ407	5/16	7/16	6

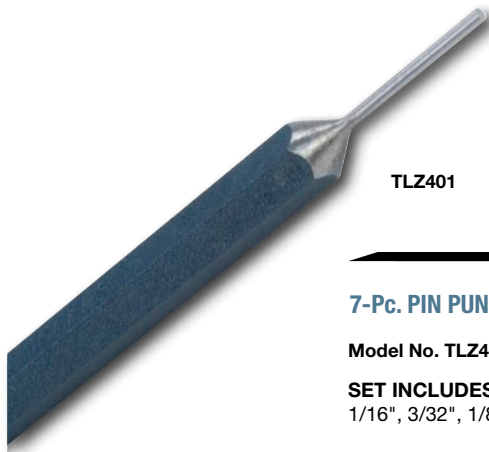

TLZ401

### 7-Pc. PIN PUNCH SET

Model No. TLZ421

SET INCLUDES SIZES:  
1/16", 3/32", 1/8", 5/32", 3/16", 7/32", & 1/4"



### DRIFT PUNCHES

- Ideal for lining up holes in two or more pieces of metal and for drawing pins through various assemblies
- Manufactured from high quality carbon steel
- Single piece construction with hexagonal shank increases durability
- Accurately hardened for increased service life



Model No.	Point Diameter"	Stock Size"	Overall Length"
TLZ408	1/8	5/16	8
TLZ409	5/32	3/8	9
TLZ410	3/16	1/2	10
TLZ411	7/32	1/2	10
TLZ412	1/4	5/8	12
TLZ413	5/16	3/4	12
TLZ414	3/8	3/4	15



#### 7-PC. DRIFT PUNCH SET

Model No. TLZ422

#### SET INCLUDES SIZES:

1/8", 5/32", 3/16", 7/32", 1/4", 5/16", & 3/8"



TLZ408

### CENTER PUNCH

- Single piece construction with hexagonal shank increases durability
- Manufactured from high quality carbon steel
- Accurately hardened for increased service life
- Beveled striking end to prevent breakage
- Working tips centered and ground to 90° for increased marking efficiency



Model No.	Point Diameter"	Stock Size"	Overall Length"
TLZ415	5/64	1/4	3-1/2
TLZ416	1/8	5/16	4-1/4
TLZ417	5/32	3/8	5
TLZ418	1/4	1/2	6
TLZ419	3/8	5/8	6-1/4



#### 5-PC. CENTER PUNCH SET

Model No. TLZ423

#### SET INCLUDES SIZES:

5/64", 1/8", 5/32", 1/4", & 3/8"



TLZ417



## PUNCH & CHISEL SETS

- Punch and chisel sets are an excellent way to keep your tools organized
- These sets are packed in heavy-duty vinyl rolls for easy access, organization and storage.



### 8-PC. PUNCH AND CHISEL SET:

Model No. TLZ433

#### SET INCLUDES:

Model No.	Style	Size"
TLZ398	Cold Chisel	1/2
TLZ399	Cold Chisel	5/8
TLZ400	Cold Chisel	3/4
TLZ417	Center Punch	5/32
TLZ403	Pin Punch	1/8
TLZ405	Pin Punch	3/16
TLZ406	Pin Punch	1/4
TLZ410	Drift Punch	3/16

### 14-PC. PUNCH AND CHISEL SET:

Model No. TLZ434

#### SET INCLUDES:

Model No.	Style	Size"
TLZ397	Cold Chisel	3/8
TLZ398	Cold Chisel	1/2
TLZ399	Cold Chisel	5/8
TLZ400	Cold Chisel	3/4
TLZ556	Cold Chisel	7/8
TLZ416	Center Punch	1/8
TLZ417	Center Punch	5/32
TLZ418	Center Punch	1/4
TLZ401	Pin Punch	1/16
TLZ403	Pin Punch	1/8
TLZ405	Pin Punch	3/16
TLZ408	Drift Punch	1/8
TLZ409	Drift Punch	5/32
TLZ413	Drift Punch	5/16



## COLD CHISELS WITH GRIP GUARD

- Individually forged from high quality alloy steel
- Manufactured to the highest safety standards
- Precisely ground cutting edge is induction hardened to 52-58 HRC
- Striking head is hardened to 42 HRC to prevent splintering during use



Model No.	Cut Width"	Stock Size"	Overall Length"
TYB509	3/4	5/8	10
TYB510	3/4	5/8	12
TYB511	1	7/8	10
TYB512	1	7/8	12

## SCRIBER WITH MAGNET

- The scriber is the perfect tool for making sharp accurate lines on hardened materials
- End cap magnet picks up stray metal shavings
- Works easily on metal, plastic, ceramics, glass and more
- Equipped with a convenient pocket-clip and cap
- Overall Length: 5"
- Tip Material: Tungsten Carbide

Model No. UAK142



## ▶ RATCHETS:

**1/4" DRIVE, 5-1/2" L**  
Model No. TYL032



**1/4" DRIVE QUICK-RELEASE, 5-3/4" L**  
Model No. TLV363



**1/4" DRIVE QUICK-RELEASE WITH RUBBER GRIP, 6" L**  
Model No. TLV380



## ▶ DRIVE HINGE HANDLE

**1/4" DRIVE, 5-3/4" L**  
Model No. TYL033



## ▶ PLASTIC HANDLE DRIVER

**1/4" DRIVE, 6" L**  
Model No. TLV445



## ▶ EXTENSIONS

**1/4" DRIVE, 2" L**  
Model No. TYK843



**1/4" DRIVE, 4" L**  
Model No. TLV446



**1/4" DRIVE, 6" L**  
Model No. TYL034



## ▶ DRIVE ADAPTOR

**1/4" DRIVE, 3/8" M**  
Model No. TYL035



## ▶ UNIVERSAL JOINT

**1/4" DRIVE, 1-1/2" L**  
Model No. TYO577



## ▶ 1/4" DRIVE S.A.E STANDARD LENGTH SOCKETS 6-POINT



Model No.	Hex Size"	Length"
TYK732	5/32	1
TYK733	3/16	1
TYK734	7/32	1
TYK735	1/4	1
TYK736	9/32	1
TYK737	5/16	1
TYK738	11/32	1
TYK739	3/8	1
TYK740	7/16	1
TYK741	1/2	1
TYK742	9/16	1

## ▶ 1/4" DRIVE S.A.E DEEP LENGTH SOCKETS 6-POINT



Model No.	Hex Size"	Length"
TYK791	5/32	2
TYK792	3/16	2
TYK793	7/32	2
TLV496	1/4	2
TYK794	9/32	2
TYK795	5/16	2
TYK796	11/32	2
TYK797	3/8	2
TYK798	7/16	2
TYK799	1/2	2
TYK800	9/16	2

## ▶ 1/4" DRIVE METRIC STANDARD LENGTH SOCKETS 6-POINT



Model No.	Hex Size mm	Length mm
TYK743	4	25
TYK744	4.5	25
TYK745	5	25
TYK746	5.5	25
TYK747	6	25
TYK748	7	25
TYK591	8	25
TYK750	9	25
TYK592	10	25
TYK752	11	25
TYK753	12	25
TYK754	13	25
TYK755	14	25

## ▶ 1/4" DRIVE METRIC DEEP LENGTH SOCKETS 6-POINT

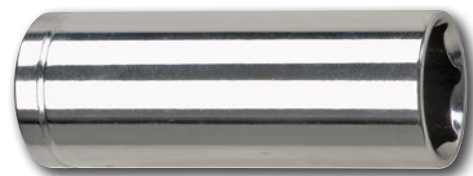

Model No.	Hex Size mm	Length mm
TYK801	4	50
TYK802	4.5	50
TYK803	5	50
TYK804	5.5	50
TYK805	6	50
TLV497	7	50
TLV553	8	50
TYK806	9	50
TLV498	10	50
TYK807	11	50
TYK808	12	50
TYK809	13	50
TYK810	14	50

## RATCHETS

**3/8" DRIVE, 7-7/8" L**  
Model No. TNB484



**3/8" DRIVE QUICK-RELEASE, 8" L**  
Model No. TLV364



**3/8" DRIVE QUICK-RELEASE WITH RUBBER GRIP, 8" L**

Model No. TLV381



## HINGE HANDLES

**3/8" DRIVE, 9-1/2" L**  
Model No. TYL037

**3/8" DRIVE, 8-1/2" L**  
Model No. TYL038



## EXTENSIONS

**3/8" DRIVE, 3" L**  
Model No. TLV365

**3/8" DRIVE, 8" L**  
Model No. TJZ226



**3/8" DRIVE, 6" L**  
Model No. TLV366

**3/8" DRIVE, 12" L**  
Model No. TYL040



## ADAPTORS

**3/8" DRIVE, 1/4" M**  
Model No. TYL041

**3/8" DRIVE, 1/2" M**  
Model No. TYK847



## SPARK PLUG SOCKETS

**3/8" DRIVE, 5/8"**  
Model No. TYL042

**3/8" DRIVE, 13/16"**  
Model No. TYL043



## UNIVERSAL JOINT

**3/8" DRIVE, 2-1/4" L**  
Model No. TYK844



## ▶ 3/8" DRIVE S.A.E STANDARD LENGTH SOCKETS 6-POINT



Model No.	Hex Size"	Length"
TLV367	1/4	1-1/8
TLV368	5/16	1-1/8
TYK756	3/8	1-1/8
TLV488	7/16	1-1/8
TMB048	1/2	1-1/8
TLV369	9/16	1-1/8
TYK757	5/8	1-1/8
TLV473	11/16	1-1/8
TLV474	3/4	1-1/8
TMB044	13/16	1-1/8
TMB045	7/8	1-1/8

## ▶ 3/8" DRIVE S.A.E DEEP LENGTH SOCKETS 6-POINT



Model No.	Hex Size"	Length"
TYL048	1/4	2-1/2
TYK811	5/16	2-1/2
TYK812	3/8	2-1/2
TLV370	7/16	2-1/2
TLV371	1/2	2-1/2
TLV372	9/16	2-1/2
TMB047	5/8	2-1/2
TLV475	11/16	2-1/2
TLV373	3/4	2-1/2
TLV374	13/16	2-1/2
TLV476	7/8	2-1/2

## ▶ 3/8" DRIVE METRIC STANDARD LENGTH SOCKETS 6-POINT



Model No.	Hex Size mm	Length mm
TYK758	6	28
TYK759	7	28
TYK760	8	28
TYK761	9	28
TMB046	10	28
TYK762	11	28
TMB049	12	28
TMB052	13	28
TYK763	14	28
TYK764	15	28
TYK765	16	28
TYK766	17	28
TYK767	18	30
TMB054	19	30
TYL044	20	30
TYL045	21	30
TYL046	22	30
UAD527	23	30

## ▶ 3/8" DRIVE METRIC DEEP LENGTH SOCKETS 6-POINT



Model No.	Hex Size mm	Length mm
TYL050	6	63
TYK593	7	63
TYK813	8	63
TYK814	9	63
TYK815	10	63
TYK816	11	63
TMB053	12	63
TYK817	13	63
TYK818	14	63
TYK819	15	63
TYK820	16	63
TYK821	17	63
TYK822	18	63
TYK823	19	63
TYL052	20	63
TYL053	21	63
TYL054	22	63
TYL055	23	63

## ▶ RATCHETS

**1/2" DRIVE, 10" L**  
Model No. TLV375



**1/2" DRIVE QUICK-RELEASE, 10" L**  
Model No. TLV376



**1/2" DRIVE QUICK-RELEASE WITH RUBBER GRIP, 10" L**  
Model No. TLV382



## ▶ HINGE HANDLE

**1/2" DRIVE, 14-1/4" L**  
Model No. TTB977



## ▶ EXTENSIONS

**1/2" DRIVE, 3" L**  
Model No. TYL058



**1/2" DRIVE, 5" L**  
Model No. TLV377

**1/2" DRIVE, 10" L**  
Model No. TYK848



## ▶ ADAPTORS

**1/2" DRIVE, 3/8" M**  
Model No. TYL056

**1/2" DRIVE, 3/4" M**  
Model No. TYL057



## ▶ UNIVERSAL JOINT

**1/2" DRIVE, 3" L**  
Model No. TLV378



## ▶ SPEED HANDLE

**1/2" DRIVE**  
Model No. TNB489



## ▶ SPARK PLUG SOCKETS

**1/2" DRIVE, 5/8"**  
Model No. TYK845

**1/2" DRIVE, 13/16"**  
Model No. TYK846



## ▶ 1/2" DRIVE S.A.E STANDARD LENGTH SOCKETS 6-POINT



Model No.	Hex Size"	Length"
TYK768	3/8	1-1/2
TYK769	7/16	1-1/2
TTB978	1/2	1-1/2
TMB050	9/16	1-1/2
TYK771	5/8	1-1/2
TYJ946	11/16	1-1/2
TMB051	3/4	1-1/2
TYK648	13/16	1-1/2
TNB728	7/8	1-1/2
TYL059	15/16	1-9/16
TYK775	1	1-11/16
TYL060	1-1/16	1-13/16
TYL061	1-1/8	1-13/16
TYL062	1-3/16	1-13/16
TYL063	1-1/4	1-13/16

## ▶ 1/2" DRIVE S.A.E DEEP LENGTH SOCKETS 6-POINT



Model No.	Hex Size"	Length"
TYK824	7/16	3-1/16
TYK825	1/2	3-1/16
TYK826	9/16	3-1/16
TYK827	5/8	3-1/16
TYK828	11/16	3-1/16
TYK829	3/4	3-1/16
TYK830	13/16	3-1/16
TYK831	7/8	3-1/16
TLV379	15/16	3-1/16
TYL067	1	3-1/16
TYL068	1-1/16	3-1/16
TYK649	1-1/8	3-1/16
TYL069	1-1/4	3-1/16

## ▶ 1/2" DRIVE METRIC STANDARD LENGTH SOCKETS 6-POINT



Model No.	Hex Size mm	Length mm
TYK776	10	38
TYK777	11	38
TYK778	12	38
TYK779	13	38
TYK780	14	38
TYK781	15	38
TYK782	16	38
TYK783	17	38
TYK784	18	38
TYK785	19	38
TYK786	20	38
TYK787	21	38
TYK788	22	38
TYK789	23	40
TYK790	24	40
TYL064	27	44
TYL065	30	44
TYL066	32	44

## ▶ 1/2" DRIVE METRIC DEEP LENGTH SOCKETS 6-POINT



Model No.	Hex Size mm	Length mm
TYK832	10	77
TYK833	11	77
TYK834	12	77
TYK835	13	77
TYK836	14	77
TYL070	15	77
TYK837	16	77
TYK838	17	77
TYL071	18	77
TYK839	19	77
TYK840	20	77
TYK841	21	77
TYK842	22	77
TYL072	23	77
TYL073	24	77
TYL074	27	77
TYL075	30	77
TYL076	32	77

## 22-PIECE 1/4" DRIVE S.A.E. SOCKET SET

- Chrome vanadium steel for extra strength and durability
- Ratchets feature a quick-release button for easy changing of attachments
- Ratchet with contoured handle for comfort and added torque
- Chrome-plated sockets to resist rust
- 6-points sockets for snug fit
- Laser-marked socket size on each socket for easy identification
- Meets ANSI standards

### SET INCLUDES:

#### • 9 Standard Sockets:

- 3/16", 7/32", 1/4", 9/32", 5/16", 11/32", 3/8", 7/16", 1/2"

#### • 7 Deep Sockets:

- 1/4", 9/32", 5/16", 11/32", 3/8", 7/16", 1/2"

#### • 6 Accessories:

- 1 Quick-release Ratchet 1/4" Drive
- 1 Plastic Handle Driver 1/4" Drive
- 1 Drive Palm Ratchet
- 1 Universal Joint
- 2 Extensions: 2" & 6"

Model No. TLV356



## 20-PIECE 3/8" DRIVE S.A.E. SOCKET SET

- Chrome vanadium steel for extra strength and durability
- Ratchets feature a quick-release button for easy changing of attachments
- Ratchet with contoured handle for comfort and added torque
- Chrome-plated sockets to resist rust
- 6-points sockets for snug fit
- Laser-marked socket size on each socket for easy identification
- Meets ANSI standards

### SET INCLUDES:

#### • 9 Standard Sockets:

- 3/8", 7/16", 1/2", 9/16", 5/8", 11/16", 3/4", 13/16", 7/8"

#### • 8 Deep Sockets:

- 3/8", 7/16", 1/2", 9/16", 5/8", 11/16", 3/4", 13/16"

#### • 3 Accessories:

- Quick Release Ratchet
- 2 Extensions: 2" & 3"

Model No. TLV357





## ▶ 24-PIECE 3/8" DRIVE METRIC SOCKET SET

- Chrome vanadium steel for extra strength and durability
- Ratchets feature a quick-release button for easy changing of attachments
- Ratchet with contoured handle for comfort and added torque
- Chrome-plated sockets to resist rust
- 6-points sockets for snug fit
- Laser-marked socket size on each socket for easy identification
- Meets ANSI standards

### SET INCLUDES:

- **13 Standard Sockets:**
- 7, 8, 9, 10, 11, 12, 13, 14, 15, 16, 17, 18, 19 mm
- **8 Deep Sockets:**
- 10, 11, 12, 13, 14, 15, 17, 19 mm
- **3 Accessories:**
- Spark Plug Socket 16 mm
- Ratchet
- 3" Extension

Model No. TLV358



## ▶ 29-PIECE 1/2" DRIVE S.A.E./METRIC SOCKET SET

- Chrome vanadium steel for extra strength and durability
- Ratchets feature a quick-release button for easy changing of attachments
- Ratchet with contoured handle for comfort and added torque
- Chrome-plated sockets to resist rust
- 6-points sockets for snug fit
- Laser-marked socket size on each socket for easy identification
- Meets ANSI standards

### SET INCLUDES:

- **24 Standard Sockets:**
- 3/8", 7/16", 1/2", 9/16", 5/8", 11/16", 3/4", 13/16", 7/8", 15/16", 1"
- 9, 10, 11, 12, 13, 14, 15, 16, 17, 18, 19, 20, 21 mm
- **5 Accessories:**
- Quick Release Ratchet
- **Extensions:** 5" & 10"
- Universal Joint
- 3/8" Drive Adapter (3/8" F x 1/2" M)

Model No. TLV359



### 41-PIECE 1/4" & 3/8" DRIVE S.A.E./METRIC SOCKET SET

- Chrome vanadium steel for extra strength and durability
- Ratchet with contoured handle for comfort and added torque
- Chrome-plated sockets to resist rust
- 6-point sockets for a snug fit
- Laser-marked socket size on each socket for easy identification
- Meets ANSI standards



#### SET INCLUDES:

##### 19 Standard Sockets (1/4"):

3/16", 7/32", 1/4", 9/32", 5/16", 11/32", 3/8", 7/16", 1/2"

4, 4.5, 5, 6, 7, 8, 9, 10, 11, 12 mm

##### 16 Standard Sockets (3/8"):

3/8", 7/16", 1/2", 9/16", 5/8", 11/16", 3/4", 13/16"  
10, 11, 12, 13, 14, 15, 17, 19 mm

#### • 6 Accessories:

- Quick Release Ratchet 3/8" Drive
- 3" - 3/8" Drive Extension
- 6" - 3/8" Drive Extension
- Universal Joint 3/8" Drive
- 3/8" Drive Adapter (3/8" F x 1/4" M)
- Plastic Handle Driver 1/4"

Model No. TLV360

### 120-PIECE 1/4", 3/8" & 1/2" DRIVE S.A.E./METRIC SOCKET SET

- Chrome vanadium steel for extra strength and durability
- Ratchet with contoured handle for comfort and added torque
- Chrome-plated sockets to resist rust
- 6-point sockets for a snug fit
- Laser-marked socket size on each socket for easy identification
- Meets ANSI standards



#### SET INCLUDES:

##### 20 Standard Sockets (1/4"):

5/32", 3/16", 7/32", 1/4", 9/32", 5/16", 11/32", 3/8", 7/16", 1/2"  
4, 5, 6, 7, 8, 9, 10, 11, 12, 13 mm

##### 18 Standard Sockets (3/8"):

3/8", 7/16", 1/2", 9/16", 5/8", 11/16", 3/4"  
9, 10, 11, 12, 13, 14, 15, 16, 17, 18, 19 mm

##### 13 Standard Sockets (1/2"):

13/16", 7/8", 15/16", 1", 1-1/16", 1-1/4"  
20, 21, 22, 24, 27, 30, 32 mm

##### 4 Deep Sockets (1/4"):

8, 9, 10, 11 mm

##### 4 Deep Sockets (3/8"):

13, 14, 15, 17 mm

##### 8 Torx Sockets (3/8"):

E8, E10, E11, E12, E14, E16, E18, E20

##### 4 Impact Sockets (1/2"):

17, 19, 21, 24 mm

##### 7 Torx Bits (1/4"):

T10, T15, T20, T25, T27, T30, T40

##### 17 Bit Sockets (3/8"):

Torx: T20, T30 T40, T45, T50, T55, T60

Hex: 3, 4, 5, 6 mm

Phillips: #1, #2

Slotted: 5.5, 6.5 mm

Pozidriv: #1, #2

##### 23 Accessories:

Quick Release Ratchet: 1/4", 3/8", & 1/2"

Spark Plug Socket 3/8" Drive: 16, 21 mm

Universal Joint: 1/4", 3/8" & 1/2"

Extension 1/4" Drive: 2"

Extension 3/8" Drive: 3" & 6"

Extension 1/2" Drive: 5" & 10"

Plastic Handle Driver 1/4" Drive

Bit Adapter 1/4" Drive

Combination Wrench: 8, 9, 10, 11, 12, 13, 14, 17, 18, 19 mm

Model No. TLV361

## ▶ 210-PIECE 1/4", 3/8" & 1/2" DRIVE S.A.E./METRIC SOCKET & WRENCH SET

- Chrome vanadium steel for extra strength and durability
- Ratchet with contoured handle for comfort and added torque
- Chrome-plated sockets to resist rust
- 6-point sockets for a snug fit
- Laser-marked socket size on each socket for easy identification
- Meets ANSI standards

### SET INCLUDES:

#### 24 Standard Sockets (1/4"):

5/32", 3/16", 7/32", 1/4", 9/32", 5/16",  
11/32", 3/8", 7/16", 1/2", 9/16"  
4, 4.5, 5, 6, 6.5, 7, 8, 9, 10, 11, 12, 13, 14 mm

#### 25 Standard Sockets (3/8"):

1/4", 9/32", 5/16", 11/32", 3/8",  
7/16", 1/2", 9/16", 5/8", 11/16", 3/4"  
6, 7, 8, 9, 10, 11, 12, 13, 14, 15, 16, 17, 18, 19 mm

#### 27 Standard Sockets (1/2"):

5/16", 3/8", 7/16", 1/2", 9/16", 5/8", 11/16", 3/4", 7/8", 1"  
8, 9, 10, 11, 12, 13, 14, 15, 16, 17, 18, 19, 20, 21, 22, 23, 24 mm

#### 15 Seep Sockets (1/4"):

1/4", 5/16", 3/8", 7/16", 1/2", 9/16"  
6, 7, 8, 9, 10, 11, 12, 13, 14 mm

#### 20 Seep Sockets (3/8"):

5/16", 3/8", 7/16", 1/2", 9/16", 5/8", 11/16", 3/4"  
8, 9, 10, 11, 12, 13, 14, 15, 16, 17, 18, 19 mm

#### 21 Deep Sockets (1/2"):

5/16", 3/8", 7/16", 1/2", 5/8", 9/16", 11/16", 3/4", 13/16", 7/8"  
10, 11, 12, 13, 14, 16, 17, 19, 20, 21, 22 mm

#### 30 Shank Bits (1/4"):

Phillips: #0, #1, #2, #3  
Slotted 3, 4, 5, 6, 7, 8 mm  
Pozidriv: #0, #1, #2, #3  
Hex: 2, 3, 4, 5, 6, 8 mm  
Torx: T8, T10, T15, T20, T25, T27, T30  
Square: 1, 2, 3

#### 12 Shank Bits (8 mm):

Phillips: #3, #4  
Pozidriv: #3, #4  
Hex: 8, 10, 12, 14 mm  
Torx: T40, T45, T50, T55

#### 36 Accessories:

Quick Release Ratchet 1/4", 3/8", 1/2"  
Spark Plug Socket 1/2" Drive: 16, 21 mm  
Universal Joint 1/4", 3/8", 1/2"  
Extension 1/4" Drive: 2" & 4"  
Extensions 3/8" Drive: 3" & 6"  
Extensions 1/2" Drive: 5" & 10"  
Plastic Handle Driver 1/4" Drive  
Sliding T-bar: 1/4" & 3/8"  
3-way Adapter (3/8" F x 1/2" M)  
Bit Adapter 1/4" Drive  
Bit Adapter 1/2" Drive  
Combination Wrench:  
5/16", 3/8", 7/16", 1/2", 9/16", 5/8", 11/16", 3/4"  
8, 10, 11, 13, 14, 16, 18, 19 mm



Model No. TLV362



## ELECTRONIC DIGITAL CALIPERS

- Large LCD display provides easy-to-read numbers
- Hardened stainless steel body
- Precision adjustments for accurate measurements
- Lock screw to hold slide in position
- Inch/millimeter conversion
- Zero at any position
- Linear accuracy:  $\pm 0.001"$  (0.03 mm)
- Deluxe storage case with foam insert
- ON/OFF button



Model No.	L"	Description	Measurement Range	Jaw Depth Outside - Inside	Batteries
TLV181	6	Stainless Steel Body, Plastic Head	0 - 6"	1-9/16" - 13/16"	Two 3.0 V, type CR3032
TGZ370	6	Stainless Steel Body, Zinc Alloy Head	0 - 6"	1-9/16" - 13/16"	Two 1.5 V
TJZ861	8	Stainless Steel Body, Zinc Alloy Head	0 - 8"	1-13/16" - 1"	Two 1.5 V
THZ769	12	Stainless Steel Body, Zinc Alloy Head	0 - 12"	2-3/8" - 1")	Two 1.5 V

## ELECTRONIC DIGITAL MICROMETER

- Large LCD display provides easy-to-read numbers
- Carbide tipped measurement surfaces
- Resolution to 5 decimal places
- Linear accuracy:  $\pm 0.0001"$  (.003 mm)
- Inch/millimeter conversion
- Thimble ratchet
- Zero at any position
- Lock screw to hold mechanism in position
- Automatic OFF button
- Includes: Calibration wrench, two 1.5 V batteries, type LR44, plastic storage case with foam insert



Model No.	Measurement Range	Resolution
IA388	0-1" (0-25 mm)	0.00005" (0.001 mm)

## MEASURING WHEEL

- Resolution: 0.1 m
- Power: 3V (2x LR3 Batteries)
- Suitable Temperature: -10°C to +45°C
- Lightweight and easy to use, designed for professional and personal usage
- Large wheel model ensures accuracy and is ideal for uneven terrain
- Suitable for outdoor and indoor distance measuring applications
- Pistol grip handle for ergonomic comfort
- Backlight for low light conditions
- Metric and imperial measurement with 5 memory storage entries
- Accuracy of  $\pm 0.5\%$
- Telescopic handle
- Push button reset
- Adds forward, subtracts in reverse
- Equipped with a sturdy flip-down kickstand and carrying bag for easy storage and portability
- Measuring Range: 99999.9 m
- Graduations: Feet/Metres
- Wheel Diameter: 12.5" (31.8 cm)

Model No. TYY302



# TAPE MEASURES

UAV723



- Features a compact case design, and rugged rubber over-mold for impact resistance
- Easy to use and easy to handle
- Highly durable
- Nylon-coated blades

UAV722



UAV725



UAV724



Model No.	Blade Length'	Blade Width"
UAV722	12	5/8

Model No.	Blade Length'	Blade Width"
UAV723	12	5/8
UAV724	16	1
UAV725	25	1



# LEVELS

- High accuracy vial with big bubble and 3 black lines each side
- Environmentally-friendly fluorescent liquid inside, which is anti-oxidation, anti-ultraviolet, and anti-electrostatic drift
- High strength aluminum profile
- Enhanced cross section design has high anti-bending resistance, so as to ensure constant accuracy and reliability
- Rubber handle cover features an ergonomic design for added comfort
- The end caps are covered by 2-component TPR material, making it anti-impact
- CNC milled bottom ensures a high accuracy reference base
- Non-Magnetic
- Type: I-Beam
- Material: Aluminium
- No. of Vials: 3



Model No.	Length'
UAV720	2
UAV721	4

# TOOL POUCHES & STORAGE

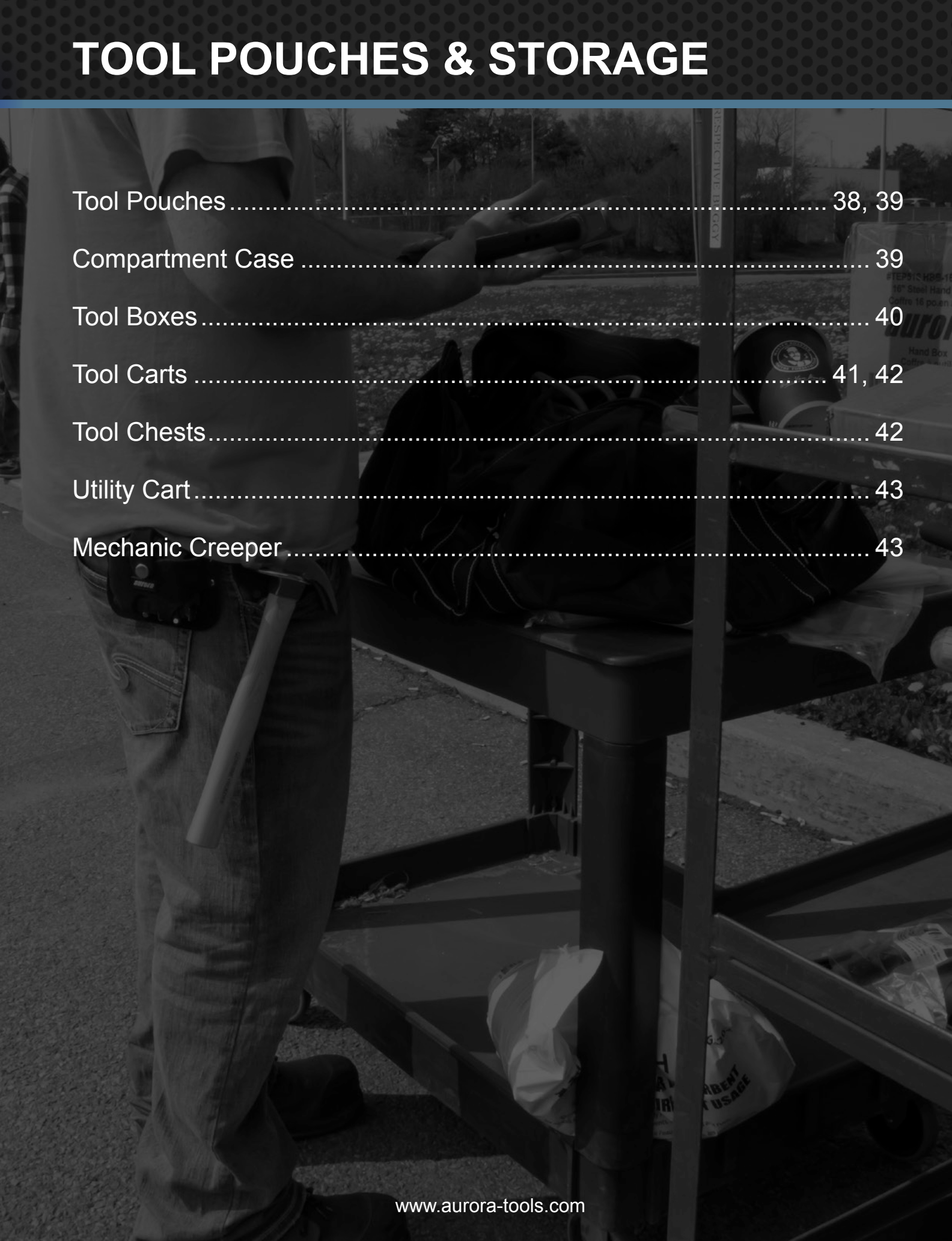

Tool Pouches .....	38, 39
Compartment Case .....	39
Tool Boxes .....	40
Tool Carts .....	41, 42
Tool Chests .....	42
Utility Cart .....	43
Mechanic Creeper .....	43

## UTILITY POUCHES

- Made of split grain leather
- Material: Leather
- Colour: Black



UAV349



UAV351



UAV352



UAV353



UAV353



UAV356

Model No.	No of Pockets	Style	Length"	Height"
UAV349	2	Knife Holder	7-3/4	2-3/4
UAV350	3	Knife Holder	11-3/4	4-3/4
UAV351	1	Plier Holder	3-1/2	9
UAV352	1	Plier Holder, Knife Holder	8-1/2	2-1/2
UAV353	1	Tape Measure Holder	6-3/4	4-1/2
UAV354	1	Plier Holder	2-1/2	8-1/4
UAV355	1	Plier Holder	9	3-1/4
UAV356	3	Multiple Tool Holder	6-1/4	9-1/4
UAV357	-	Hammer Holder	3-3/4	5 1/2



## TOOL POUCHES



TER023



TER025



TER027



TER024



TER026

Model No.	Description	Number of Pockets	Overall Dimensions W" x D" x H"
TER023	All-purpose gear bag	8	24 x 12 x 12
TER024	Maintenance tool pouch	5	3-1/2 x 1-1/2 x 8-3/4
TER025	Utility knife holder	3	6 x 3-1/2 x 9-3/4
TER026	Multi-pocket phone & tool holder	4	6-1/4 x 2 x 9-1/2
TER027	Multi-purpose tool holder	4	5-1/4 x 2 x 7-1/2

## COMPARTMENT CASES

- High strength, high quality polypropylene case
- Translucent lid allows for quick view of contents
- Snap latch ensures a secure closure
- Removable dividers allow for different configurations



CF333

Model No.	Dimensions W" x D" x H"	No. of Compartments
CF333	10-3/4 x 5-3/8 x 1-1/2	Variable up to 17
TLZ117	5-1/2 x 5-1/2 x 1-1/2	Variable up to 9

## HEAVY-DUTY TOOL BOXES

- ABS plastic latches are virtually indestructible
- Heavy-duty polypropylene construction
- Removable inner trays
- Deep storage compartments
- Padlock eye for safe storage

Model No.	Dimensions W" x D" x H"	Features
TLV082	15 x 7 x 5-1/2	1 Removable Inner Tray
TLV083	17-1/2 x 9-1/2 x 8	1 Removable Inner Tray
TLV084	17-1/2 x 9-1/2 x 8	1 Removable Inner Tray, 2 Parts Boxes, 1 Organizer
TLV085	22 x 11 x 10-1/2	1 Removable Inner Tray, 3 Organizers
TLV086	22 x 11 x 14-1/2	1 Removable Inner Tray, 3 Organizers, 2 Drawers



TLV082

TLZ117  
Parts Box



TLV083



TLV084



TLV085



TLV086

## PORTABLE TOOL BOXES

- Durable steel construction
- Heavy-plated latches
- Inner trays in regular hand boxes
- High gloss powder coat paint finish

Model No.	Description	Overall Dimensions W" x D" x H"	Wt. lbs.
TEP516	16" Portable Tool Box With Metal Tool Tray	16 x 6 x 6-1/2	10
TEP336	21" Portable Tool Box With Metal Tool Tray	21 x 8-3/4 x 9	20

TEP516



## INDUSTRIAL TOOL CARTS

- Double wall steel construction for added strength
- Full extension ball bearings slides on all drawers
- Extruded aluminum drawer handle trim
- Non-slip drawer liners
- Powder coat scratch resistant black paint
- Features 2 fixed HD casters & 2 swivel HD casters with toe locks
- Colour: Black

TER216



TER218



TER217



TER064



TER065



TER067



Model No.	No. of Drawers	Overall W" x D" x H"	Drawer Capacity lbs.	Unit Capacity lbs.	Caster Dimensions"
TER216	3	29-4/5 x 21-1/5 x 38-4/5	100	779	5 x 2
TER217	6	39 x 20-4/5 x 25-4/5	100	1140	5 x 2
TER218	8	44-3/10 x 21-1/10 x 36-7/10	100	1356	5 x 2
TER064	5	27 x 18-3/4 x 31-1/2	100	1400	5 x 2
TER065	7	27 x 18-3/4 x 39	100	1400	5 x 2
TER067	11	41 x 18-3/4 x 39-1/3	100	1400	5 x 2

## INDUSTRIAL TOOL CART

- Double-walled steel construction for added strength
- Full extension ball bearings slides on all drawers
- Double drawer glides on the top drawer
- Extruded aluminum drawer handle trim
- Keyed locking system for added security
- Round side chromed handle
- Non-slip drawer liners
- Tick top mat provides an excellent work surface
- High-gloss powder coat scratch-resistant paint
- Includes: 2 fixed HD casters & 4 swivel HD casters with toe locks - 5" (127mm) x 2" (51mm)
- Colour: Red



Model No.	No of Drawers	Overall W" x H" x D"	Drawer Capacity lbs.	Unit Capacity lbs.	Overall Weight lbs.	Caster Dimensions"
TER103	12	56 x 38-1/8 x 24-1/2	100	1200	302	5 x 2

## HEAVY-DUTY TOOL CART

- Heavy-duty double wall steel construction for added strength
- Quadra level ball bearing slides on all drawers
- Drawers feature soft close technology
- Heavy-duty reinforced bottom support rails for heavier loads
- Full extension slides for easy reach inside
- Integrated latch security drawer system prevents drawers from accidentally opening
- Powder coat scratch resistant black paint
- Non-slip drawer liners and a thick rubber top mat that provides an excellent working surface
- Power and USB outlets on the side of the cabinet makes it quick and easy to charge your power tools and mobile devices
- Heavy-duty casters with double layer ball bearings



Model No.	No of Drawers	Colour	Overall W" x H" x D"	Drawer Capacity lbs.	Unit Capacity lbs.	Caster Dimensions"
TER069	7	Black	28 x 42-3/8 x 22	120	1400	5 x 2

## INDUSTRIAL TOOL CHESTS

- Double wall steel construction for added strength
- Full extension ball bearings slides on all drawers
- Extruded aluminum drawer handle trim
- Powder coat scratch resistant black paint
- Gas struts are in the lid of the chest for ease of opening and closing



Model No.	No of Drawers	Colour	Overall W" x H" x D"	Drawer Capacity lbs.	Unit Capacity lbs.
TER066	4	Black	26 x 14-1/4 x 12	75	375
TER068	10	Black	41 x 19 x 17-3/4	100	1000

## UTILITY CART

- Heavy-duty steel construction
- Full extension ball bearing slides on all drawers
- High quality 4" swivel casters
- Drawer capacity: 100 lbs.
- Unit capacity: 550 lbs.
- High gloss powder coat scratch resistant black paint
- Assembly required



TEP483



Model No.	No. of Drawers	Dimensions W" x D" x H"	Wt. lbs.
TEP483	4	37 x 18-3/8 x 40-1/2	95

## MECHANIC CREEPER

- Built-in, padded, adjustable headrest
- 360° swivel casters
- Built-in handle makes it easy to adjust the headrest to alleviate neck pain
- Headrest: Adjustable
- Weight Capacity: 265 lbs.
- Overall Length: 16-3/4"
- Overall Width: 40-1/4"
- Overall Height: 4-3/4"
- Material: Vinyl
- Colour: Black
- No. of Casters: 6
- Caster Material: Steel

Model No. FLT527



# TOOLS KITS

A grayscale photograph of a person's hands, wearing white gloves, working on the engine of a car. The person is using a screwdriver to adjust a component. The engine bay is filled with various parts, hoses, and a large black air filter. The background is dark and textured.

Basic Tool Set .....	45
Essential Tool Set .....	45
Maintenance Tool Set .....	46
Deluxe Tool Set .....	46
Tradesman Tool Set .....	47
Starter Tool Set .....	47
Intermediate Tool Set .....	48
Professional Tool Set .....	49
Master Tool Set .....	50
Ultimate Tool Set .....	51

## ▶ BASIC TOOL SET

### SET INCLUDES:

- TLV083 Tool Box
- TJZ062 1/4" Slot Screwdriver, 5" Shank
- TJZ068 #2 Phillips Screwdriver, 4" Shank
- TJZ073 #2 Square Tip Screwdriver, 6" Shank
- TJZ033 Hammer, 16-oz. Claw
- TJZ079 Groove Joint Pliers, 8" L
- UAV658 Diagonal Cutting Pliers, 6" L
- UAV660 Long Nose Pliers, 6" L
- TJZ092 Locking Pliers, 7" L
- UAV667 Long Nose Locking Pliers, 6.5" L
- TJZ117 Measuring Tape, 16' L
- PE549 Utility Knife
- TJZ102 Adjustable Combo Wrench, 10" L
- TJZ060 1/4" Stubby Slot Screwdriver, 1-1/2" Shank
- TJZ069 #2 Stubby Phillips Screwdriver, 1-1/2" Shank
- TJZ076 #2 Stubby Square Tip Screwdriver, 1-1/2" Shank
- TJZ075 #1 Stubby Square Tip Screwdriver, 1-1/2" Shank

Model No. TLV075



## ▶ ESSENTIAL TOOL SET

### SET INCLUDES:

- TLV084 Tool Box
- TJZ072 #1 Square Screwdriver, 4" Shank
- TJZ073 #2 Square Screwdriver, 6" Shank
- TJZ067 #1 Phillips Screwdriver, 3-1/4" Shank
- TJZ068 #2 Phillips Screwdriver, 4" Shank
- TJZ062 1/4" Slot Screwdriver, 5" Shank
- TJZ064 5/16" Slot Screwdriver, 6" Shank
- TNB733 Hex Key Set, S.A.E.
- TJZ801 Measuring Tape, 1" W x 25' L, in/ft
- UAV655 Slip Joint Pliers, 6" L
- UAV658 Diagonal Cutting Pliers, 6" L
- UAV660 Long Nose Pliers, 6" L
- TJZ091 Locking Pliers, 5" L
- UAV667 Long Nose Locking Pliers, 6.5" L
- TJZ101 Adjustable Wrench, 8" L
- PE549 Utility Knife
- TJZ033 Hammer, 16 oz.
- TJZ036 Dead Blow Hammer, 16 oz.
- TJZ040 Ball Pein Hammer, 16 oz.
- TJZ043 Rubber Mallet, 16 oz.

Model No. TYP013



## MAINTENANCE TOOL SET

### SET INCLUDES:

- TLV083 Tool Box
- PE549 Utility Knife
- TYW991 Hacksaw
- TJZ033 Hammer, 16 oz.
- TJZ043 Rubber Mallet, 16 oz.
- TNB733 Hex Key Set
- TJZ080 Groove Joint Pliers, 10" L
- UAV658 Diagonal Cutting Pliers, 6" L
- UAV660 Long Nose Cutting Pliers, 6" L
- TJZ092 Curved Jaw Locking Pliers, 7" L
- UAV667 Long Nose Locking Pliers, 6.5" L
- TJZ102 Adjustable Wrench, 10" L
- TJZ117 Measuring Tape, 16' L
- TJZ057 1/8" Slot Screwdriver, 3" Shank
- TJZ061 1/4" Slot Screwdriver, 3" Shank
- TJZ064 5/16" Slot Screwdriver, 3" Shank
- TJZ067 #1 Phillips Screwdriver, 3-1/4" Shank
- TJZ068 #2 Phillips Screwdriver, 4" Shank
- TJZ072 #1 Square Tip Screwdriver, 4" Shank
- TJZ073 #2 Square Tip Screwdriver, 6" Shank
- TLV053 S.A.E. Combo Wrench Set
- SM575 Work Gloves



Model No. TLZ459

## DELUXE TOOL SET

### SET INCLUDES:

- TLV085 Tool Box
- PE549 Utility Knife
- TYW991 Hacksaw
- TNB733 Hex Key Set, S.A.E.
- TJZ079 Groove joint pliers, 8" L
- UAV655 Slip Joint Pliers, 6" L
- UAV658 Diagonal Cutting Pliers, 6" L
- UAV660 Long Nose Pliers, 6" L
- UAV662 Linesman Pliers, 7" L
- TJZ092 Locking Pliers, 7" L
- UAV667 Long Nose Locking Pliers, 6.5" L
- TJZ102 Adjustable Wrench, 10" L
- TJZ801 Measuring Tape, 1" W x 25' L, in/ft
- TJZ058 3/16" Slot Screwdriver, 4" Shank
- TJZ060 1/4" Stubby Slot Screwdriver, 1-1/2" Shank
- TJZ063 1/4" Slot Screwdriver, 6" Shank
- TJZ067 #1 Phillips Screwdriver, 3-1/4" Shank
- TJZ070 #3 Phillips Screwdriver, 6" Shank
- TJZ072 #1 Square Screwdriver, 4" Shank
- TJZ074 #3 Square Screwdriver, 6" Shank
- TLV055 S.A.E Combo Wrench Set
- TJZ033 Hammer, 16 oz.
- TJZ043 Rubber Mallet, 16 oz.
- TJZ036 Dead Blow Hammer, 16 oz.
- TJZ040 Ball Pein Hammer, 16 oz.
- PF205 Replacement Blades



Model No. TYP012



## TRADESMAN TOOL SET

### SET INCLUDES:

<b>TLV086</b>	Tool Box	<b>TLV053</b>	11-pc. S.A.E. Wrench Set
<b>PE812</b>	Utility Knife	<b>TLV357</b>	20-pc. 3/8" S.A.E. Socket Set
<b>TYW991</b>	Hacksaw	<b>SA619</b>	Gloves
<b>TJZ033</b>	Claw Hammer, 16 oz.	<b>SGU581</b>	Glasses
<b>TJZ036</b>	Dead Blow Hammer, 16 oz.	<b>TJZ047</b>	Action Bar, 13-1/2" L
<b>TNB731</b>	Hex Keys, S.A.E., 0.05" - 3/8"		
<b>TNB732</b>	Hex Keys, Metric, 1.5 mm - 10 mm		
<b>UAV655</b>	Split Joint Pliers, 6" L		
<b>TJZ080</b>	Groove Joint Pliers, 10" L		
<b>UAV659</b>	Diagonal Cutting Pliers, 7.5" L		
<b>UAV661</b>	Long Nose Pliers, 8" L		
<b>UAV663</b>	Linesman Pliers, 8" L		
<b>UAV666</b>	Curved Jaw Locking Pliers, 10" L		
<b>UAV667</b>	Long Nose Locking Pliers, 6.5" L		
<b>TJZ102</b>	Adjustable Combo Wrench, 10" L		
<b>TJZ801</b>	Measuring Tape, 25' L		
<b>TJZ057</b>	1/8" Slot Screwdriver, 3" Shank		
<b>TJZ058</b>	3/16" Slot Screwdriver, 4" Shank		
<b>TJZ060</b>	1/4" Stubby Slot Screwdriver, 1-1/2" Shank		
<b>TJZ061</b>	1/4" Slot Screwdriver, 4" Shank		
<b>TJZ064</b>	5/16" Slot Screwdriver, 6" Shank		
<b>TJZ065</b>	3/8" Slot Screwdriver, 8" Shank		
<b>TJZ066</b>	#0 Phillips Screwdriver, 2-1/2" Shank		
<b>TJZ067</b>	#1 Phillips Screwdriver, 3-1/4" Shank		
<b>TJZ068</b>	#2 Phillips Screwdriver, 4" Shank		
<b>TJZ069</b>	#2 Stubby Phillips Screwdriver, 1-1/2" Shank		
<b>TJZ070</b>	#3 Phillips Screwdriver, 6" Shank		
<b>TJZ071</b>	#0 Square Tip Screwdriver, 4" Shank		
<b>TJZ072</b>	#1 Square Tip Screwdriver, 4" Shank		
<b>TJZ073</b>	#2 Square Tip Screwdriver, 6" Shank		
<b>TJZ074</b>	#3 Square Tip Screwdriver, 6" Shank		
<b>TJZ076</b>	#2 Stubby Square Tip Screwdriver, 1-1/2" Shank		

Model No. TLV076



## STARTER TOOL SET WITH STEEL CHEST

### SET INCLUDES:

<b>TER066</b>	ATB300 Tool Chest, 4 Drawer, 26" x 12" x 14-1/2"
<b>TJZ040</b>	Hammer, Ball Pein, 16-oz.
<b>TJZ036</b>	Hammer, Dead Blow, 16-oz.
<b>TJZ033</b>	Hammer, Hickory Handle, Claw, 16-oz.
<b>UAV655</b>	Pliers, Slip Joint, Black Nickel Finish, 6" L
<b>UAV656</b>	Pliers, Groove Joint, 8" L
<b>UAV659</b>	Pliers, Diagonal Cutting, 7" L
<b>UAV660</b>	Pliers, Long Nose, Cutting, 6" L
<b>UAV662</b>	Pliers, Linesman Cutting, 7" L
<b>TJZ092</b>	Locking Pliers, Curved Jaw w/ Wire Cutter, 7" L
<b>TLZ417</b>	Centre Punch, 5/32" x 5" L
<b>TLZ418</b>	Centre Punch, 1/4" x 6" L
<b>TLZ403</b>	Pin Punch 1/8" x 4-3/4" L
<b>TLZ405</b>	Pin Punch 3/16" x 5-1/4" L
<b>TLZ397</b>	Cold Chisel, 3/8" x 5-1/2" L
<b>TLZ398</b>	Cold Chisel, 1/2" x 6" L
<b>TLZ400</b>	Cold Chisel, 3/4" x 7" L
<b>TLZ412</b>	Drift Punch 1/4" x 12" L
<b>TJZ072</b>	Screwdriver, Square, #1 Tip, 4" Shank
<b>TJZ073</b>	Screwdriver, Square, #2 Tip, 6" Shank
<b>TJZ067</b>	Screwdriver, Phillips, #1 Tip, 3-1/4" Shank
<b>TJZ068</b>	Screwdriver, Phillips, #2 Tip, 4" Shank
<b>TJZ057</b>	Screwdriver, Slot Cabinet, 1/8" Tip, 3" Shank
<b>TJZ061</b>	Screwdriver, Slot Mechanics, 1/4" Tip, 4" Shank
<b>TJZ064</b>	Screwdriver, Slot Mechanics, 5/16" Tip, 6" Shank
<b>TJZ101</b>	Wrench, Adjustable, 8", Composite Grip
<b>TJZ103</b>	Wrench, Adjustable, 12", Composite Grip
<b>TNB733</b>	Hex Keys, S.A.E., Composite Grip Fold-up, 9 Keys
<b>TLV055</b>	Wrench Set With Pouch, 14-pc. S.A.E.
<b>TLV357</b>	Socket Set, 20-pc., 3/8" Drive S.A.E.

Model No. TLV421



## INTERMEDIATE TOOL SET WITH CART

### SET INCLUDES:

**TER065** ATB300 Tool Cart, 7 Drawer, 27" x 18" x 35-1/2"  
**TJZ057** Screwdriver, Slot Cabinet, 1/8" Tip, 3" Shank  
**TJZ058** Screwdriver, Slot Cabinet, 3/16" Tip, 4" Shank  
**TJZ060** Screwdriver, Slot Mechanics, 1/4" Tip, 1-1/2" Stubby Shank  
**TJZ061** Screwdriver, Slot Mechanics, 1/4" Tip, 4" Shank  
**TJZ064** Screwdriver, Slot Mechanics, 5/16" Tip, 6" Shank  
**TJZ065** Screwdriver, Slot Mechanics, 3/8" Tip, 8" Shank  
**TJZ066** Screwdriver, Phillips, #0 Tip, 2-1/2" Shank  
**TJZ067** Screwdriver, Phillips, #1 Tip, 3-1/4" Shank  
**TJZ068** Screwdriver, Phillips, #2 Tip, 4" Shank  
**TJZ069** Screwdriver, Phillips, #2 Tip, 1-1/2" Stubby Shank  
**TJZ070** Screwdriver, Phillips, #3 Tip, 6" Shank  
**TJZ071** Screwdriver, Square, #0 Tip, 4" Shank  
**TJZ072** Screwdriver, Square, #1 Tip, 4" Shank  
**TJZ073** Screwdriver, Square, #2 Tip, 6" Shank  
**TJZ074** Screwdriver, Square, #3 Tip, 6" Shank  
**TJZ076** Screwdriver, Square, #2 Tip, 1-1/2" Stubby Shank  
**UAV655** Pliers, Slip Joint, 6" L  
**UAV656** Pliers, Groove Joint, 8" L  
**UAV658** Pliers, Diagonal Cutting, 6" L  
**UAV659** Pliers, Diagonal Cutting, 7.5" L  
**UAV660** Pliers, Long Nose Cutting, 6" L  
**UAV661** Pliers, Long Nose Cutting, 8" L  
**UAV663** Pliers, Linesman Cutting, 8" L  
**TJZ091** Locking Pliers, Curved Jaw w/ Wire Cutter, 5" L  
**UAV666** Locking Pliers, Curved Jaw w/ Wire Cutter, 10" L  
**UAV667** Locking Pliers, Long Nose w/ Wire Cutter, 6.5" L  
**UAV668** Locking Pliers, C-Clamps 11" L

**TJZ100** Wrench, Adjustable, 6", w/ Composite Grip  
**TJZ103** Wrench, Adjustable, 12", w/ Composite Grip  
**TLV053** Wrench Set With Pouch, 11-pc. S.A.E.  
**TLV054** Wrench Set With Pouch, 11-pc. Metric  
**TNB731** Hex keys, S.A.E. Short Arm, 13 Keys, 0.05" - 3/8"  
**TLV360** Socket Set, 41-pc., 1/4" & 3/8" Drive S.A.E./Metric  
**TLZ396** Cold Chisel, 5/16" x 5" L  
**TLZ398** Cold Chisel, 1/2" x 6" L  
**TLZ400** Cold Chisel, 3/4" x 7" L  
**TLZ417** Centre Punch, 5/32" x 5" L  
**TLZ415** Centre Punch, 5/64" x 3-1/2" L  
**TLZ419** Centre Punch, 3/8" x 6-1/4" L  
**TLZ402** Pin Punch 3/32" x 4-1/2" L  
**TLZ405** Pin Punch 3/16" x 5-1/4" L  
**TLZ403** Pin Punch 1/8" x 4-3/4" L  
**TYW991** Hacksaw Frame, Standard, Adjustable 10" - 12"  
**TJZ047** Action Bar, 1-3/8" x 1/4" x 13-1/2"  
**PE812** Utility Knife, H-D, w/ Auto Reload, Snap-off Blades  
**TJZ033** Hammer, Claw, Hickory Handle, 16-oz.  
**TJZ036** Hammer, Dead Blow, 16-oz.  
**TJZ038** Hammer, Dead Blow, 32-oz.  
**TJZ040** Hammer, Ball Pein, 16-oz.  
**TJZ042** Hammer, Ball Pein, 32-oz.  
**TJZ801** Measuring Tape, HD, 1" W x 25' L, in/ft, Composite Grip

Model No. TLV422



## PROFESSIONAL TOOL SET

### SET INCLUDES:

<b>TLV086</b>	Tool Box	<b>TNB732</b>	Metric Hex Key Set
<b>PE812</b>	Utility Knife	<b>TJZ057</b>	1/8" Slot Screwdriver, 3" Shank
<b>TYW991</b>	Hacksaw	<b>TJZ058</b>	3/16" Slot Screwdriver, 3" Shank
<b>TJZ033</b>	Hammer, 16 oz.	<b>TJZ060</b>	1/4" Stubby Slot Screwdriver 1-1/2" Shank
<b>TJZ041</b>	Ball Pein Hammer, 24 oz.	<b>TJZ061</b>	1/4" Slot Screwdriver, 4" Shank
<b>TJZ047</b>	Action Bar, 13-1/2" L	<b>TJZ064</b>	5/16" Slot Screwdriver, 6" Shank
<b>UAV655</b>	Split Joint Pliers, 6" L	<b>TJZ065</b>	3/8" Slot Screwdriver, 8" Shank
<b>TJZ080</b>	Groove Joint Pliers, 10" L	<b>TJZ066</b>	#0 Phillips Screwdriver, 2-1/2" Shank
<b>UAV659</b>	Diagonal Cutting Pliers, 7.5" L	<b>TJZ067</b>	#1 Phillips Screwdriver, 3-1/4" Shank
<b>UAV661</b>	Long Nose Pliers, 8" L	<b>TJZ068</b>	#2 Phillips Screwdriver, 4" Shank
<b>UAV663</b>	Linesman Pliers, 8" L	<b>TJZ069</b>	#2 Stubby Phillips Screwdriver, 1-1/2" Shank
<b>UAV666</b>	Locking Pliers, 10" L	<b>TJZ070</b>	#3 Phillips Screwdriver, 6" Shank
<b>UAV667</b>	Long Nose Locking Pliers, 6.5"L	<b>TJZ071</b>	#0 Square Tip Screwdriver, 4" Shank
<b>TJZ102</b>	Adjustable Wrench, 10" L	<b>TJZ072</b>	#1 Square Tip Screwdriver, 4" Shank
<b>TJZ801</b>	Measuring Tape, 25' L	<b>TJZ073</b>	#2 Square Tip Screwdriver, 6" Shank
<b>TLV053</b>	S.A.E. Combo Wrench Set	<b>TJZ074</b>	#3 Square Tip Screwdriver, 6" Shank
<b>TLV054</b>	Metric Wrench Set	<b>TJZ076</b>	#2 Stubby Square Tip Screwdriver, 1-1/2" Shank
<b>TLV357</b>	24-pc. S.A.E. Socket Set	<b>SAJ023</b>	Work Gloves
<b>TLV358</b>	24-pc. Metric Socket Set	<b>SGU581</b>	Glasses
<b>TJZ861</b>	Caliper		
<b>TNB731</b>	S.A.E. Hex Key Set		

Model No. TLZ460





## MASTER TOOL SET WITH STEEL CHEST & CART

### SET INCLUDES:

- TER066 ATB300 Tool Chest, 6 Drawer, 26" x 18" x 19"
- TER065 ATB300 Tool Cart, 7 Drawer, 27" x 18" x 35-1/2"
- TJZ057 Screwdriver, Slot Cabinet, 1/8" Tip, 3" Shank
- TJZ058 Screwdriver, Slot Cabinet, 3/16" Tip, 4" Shank
- TJZ059 Screwdriver, Slot Cabinet, 3/16" Tip, 6" Shank
- TJZ060 Screwdriver, Slot Mechanics, 1/4" Tip, 1-1/2" Stubby shank
- TJZ061 Screwdriver, Slot Mechanics, 1/4" Tip, 4" Shank
- TJZ062 Screwdriver, Slot Mechanics, 1/4" Tip, 5" Shank
- TJZ063 Screwdriver, Slot Mechanics, 1/4" Tip, 6" Shank
- TJZ064 Screwdriver, Slot Mechanics, 5/16" Tip, 6" Shank
- TJZ065 Screwdriver, Slot Mechanics, 3/8" Tip, 8" Shank
- TJZ066 Screwdriver, Phillips, #0 Tip, 2-1/2" Shank
- TJZ067 Screwdriver, Phillips, #1 Tip, 3-1/4" Shank
- TJZ068 Screwdriver, Phillips, #2 Tip, 4" Shank
- TJZ069 Screwdriver, Phillips, #2 Tip, 1-1/2" Stubby Shank
- TJZ070 Screwdriver, Phillips, #3 Tip, 6" Shank
- TJZ071 Screwdriver, Square, #0 Tip, 4" Shank
- TJZ072 Screwdriver, Square, #1 Tip, 4" Shank
- TJZ073 Screwdriver, Square, #2 Tip, 6" Shank
- TJZ074 Screwdriver, Square, #3 Tip, 6" Shank
- TJZ075 Screwdriver, Square, #1 Tip, 1-1/2" Stubby Shank
- TJZ076 Screwdriver, Square, #2 Tip, 1-1/2" Stubby Shank
- TJZ077 Screwdriver, Square, #3 Tip, 1-1/2" Stubby Shank
- UAV655 Pliers, Slip Joint, 6" L
- UAV656 Pliers, Groove Joint, 8" L
- TJZ080 Pliers, Groove Joint, 10" L
- UAV658 Pliers, Diagonal Cutting, 6" L
- UAV659 Pliers, Diagonal Cutting, 7.5" L
- UAV660 Pliers, Long Nose Cutting, 6" L
- UAV661 Pliers, Long Nose Cutting, 8" L
- UAV662 Pliers, Linesman Cutting, 7" L
- UAV663 Pliers, Linesman Cutting, 8" L
- TJZ090 Locking Pliers, Curved Jaw w/ Wire Cutter, 4" L
- TJZ091 Locking Pliers, Curved Jaw w/ Wire Cutter, 5" L
- TJZ092 Locking Pliers, Curved Jaw w/ Wire Cutter, 7" L
- UAV666 Locking Pliers, Curved Jaw w/ Wire Cutter, 10" L
- TJZ094 Locking Pliers, Long Nose w/ Wire Cutter 4" L
- UAV667 Locking Pliers, Long Nose w/ Wire Cutter, 6.5" L
- TJZ096 Locking Pliers, C-Clamps w/ Swivel Pads, 6" L
- UAV668 Locking Pliers, C-Clamps 11" L
- TJZ100 Wrench, Adjustable, 6" L, w/ Composite Grip
- TJZ101 Wrench, Adjustable, 8" L, w/ Composite Grip
- TJZ102 Wrench, Adjustable, 10" L, w/ Composite Grip
- TJZ103 Wrench, Adjustable, 12" L, w/ Composite Grip
- TJZ104 Wrench, Adjustable, 15" L
- TJZ105 Wrench, Adjustable, 18" L
- TJZ108 Wrench, Straight Pipe, 12" L, 2" Pipe Capacity
- TLV055 Wrench Set With Pouch, 14-pc. S.A.E.
- TLV056 Wrench Set With Pouch, 14-pc. Metric
- TLV356 Socket Set, 22-pc., 1/4" Drive S.A.E.
- TLV357 Socket Set, 20-pc., 3/8" Drive S.A.E.
- TLV358 Socket Set, 24-pc., 3/8" Drive Metric
- TLV359 Socket Set, 29-pc., 1/2" Drive S.A.E./Metric
- TLZ420 Cold Chisel Set, 6-pc.
- TLZ421 Pin Punch Set, 7-pc.
- TLZ422 Draft Punch Set, 7-pc.
- TLZ423 Centre punch Set, 5-pc.
- TYW991 Hacksaw Frame, Standard, Adjustable 10" - 12"
- TJZ047 Action Bar, 13-1/2" L
- PE812 Utility Knife, H-D, w/ Auto Reload, Snap-off Blades
- TJZ033 Hammer, Hickory Handle, Claw, 16-oz.
- TJZ034 Hammer, Hickory Handle, Framing, 22-oz.
- TJZ035 Hammer, Dead Blow, 8-oz.
- TJZ036 Hammer, Dead Blow, 16-oz.
- TJZ037 Hammer, Dead Blow, 24-oz.
- TJZ038 Hammer, Dead Blow, 32-oz.
- TJZ039 Hammer, Ball Pein, 8-oz.
- TJZ040 Hammer, Ball Pein, 16-oz.
- TJZ041 Hammer, Ball Pein, 24-oz.
- TJZ042 Hammer, Ball Pein, 32-oz.
- TJZ043 Mallet, Black, 16-oz.
- TJZ044 Mallet, Black, 32-oz.
- TNB731 Hex Keys, S.A.E. Short Arm, 13 Keys, 0.050" - 3/8"
- TNB732 Hex keys, Metric Short Arm, 9 Keys, 1.5 mm - 10 mm
- TJZ801 Measuring Tape, HD, 1" W x 25' L, in/ft, Composite Grip
- TJZ802 Measuring Tape, HD, 1" W x 25' L, in/cm, Composite Grip
- TJZ861 Digital Caliper, Stainless Steel, 8" L
- AD084 Mini Grease Gun, Push Type, 80 CC

Model No. TLV423

## ▶ ULTIMATE TOOL SET

Looking for a tool. . . Look no further. This ultimate set includes most of the items you will find in this catalogue.



Model No. TYO941



### SET INCLUDES:

**TER068** ATB400 Tool Chest, 6 Drawers  
**TER067** ATB400 Tool Cart, 14 Drawers  
**AC509** Grease Fitting Set  
**AD084** Grease Gun  
**PF205** Replacement Blades  
**PE812** Utility Knife  
**THZ769** Caliper  
**IA388** Micrometer  
**TJZ801** Measuring Tape, 1" W x 25' L in/ft  
**TJZ802** Measuring Tape, 1" W x 25' L in/cm  
**TYW991** Hacksaw  
**TJZ033** Claw Hammer, 16 oz.  
**TJZ034** Claw Hammer, 22 oz.  
**TJZ035** Dead Blow Hammer, 8 oz.  
**TJZ036** Dead Blow Hammer, 16 oz.  
**TJZ037** Dead Blow Hammer, 24 oz.  
**TJZ038** Dead Blow Hammer, 32 oz.  
**TJZ039** Ball Pein Hammer, 8 oz.  
**TJZ040** Ball Pein Hammer, 16 oz.  
**TJZ041** Ball Pein Hammer, 24 oz.  
**TJZ042** Ball Pein Hammer, 32 oz.  
**TJZ043** Rubber Mallet, Black, 16 oz.  
**TJZ044** Rubber Mallet, Black, 32 oz.  
**TJZ047** Action Bar 13-1/2" L  
**TJZ048** Wrecking Bar, 18" L  
**TJZ049** Wrecking Bar, 24" L  
**TJZ057** 1/8" Slot Screwdriver, 3" Shank  
**TJZ058** 3/16" Slot Screwdriver, 4" Shank  
**TJZ059** 3/16" Slot Screwdriver, 6" Shank  
**TJZ060** 1/4" Slot Stubby Screwdriver, 1-1/2" Shank  
**TJZ061** 1/4" Slot Screwdriver, 4" Shank

**TJZ062** 1/4" Slot Screwdriver, 5" Shank  
**TJZ063** 1/4" Slot Screwdriver, 6" Shank  
**TJZ064** 5/16" Slot Screwdriver, 6" Shank  
**TJZ065** 3/8" Slot Screwdriver, 8" Shank  
**TJZ066** #0 Phillips Screwdriver, 2-1/2" Shank  
**TJZ067** #1 Phillips Screwdriver, 3-1/4" Shank  
**TJZ068** #2 Phillips Screwdriver, 4" Shank  
**TJZ069** #2 Phillips Stubby Screwdriver, 1-1/2" Shank  
**TJZ070** #3 Phillips Screwdriver, 6" Shank  
**TJZ071** #0 Square Screwdriver, 4" Shank  
**TJZ072** #1 Square Screwdriver, 4" Shank  
**TJZ073** #2 Square Screwdriver, 6" Shank  
**TJZ074** #3 Square Screwdriver, 6" Shank  
**TJZ075** #1 Square Stubby Screwdriver, 1-1/2" Shank  
**TJZ076** #2 Square Stubby Screwdriver, 1-1/2" Shank  
**TJZ077** #3 Square Stubby Screwdriver, 1-1/2" Shank  
**UAV655** Slip Joint Pliers, 6" L  
**UAV656** Groove Joint Pliers, 8" L  
**TJZ080** Groove Joint Pliers, 10" L  
**UAV658** Diagonal Cutting Pliers, 6" L  
**UAV659** Diagonal Cutting Pliers, 7.5" L  
**UAV660** Long Nose Cutting Pliers, 6" L  
**UAV661** Long Nose Cutting Pliers, 8" L  
**UAV662** Linesman Pliers, 7" L  
**UAV663** Linesman Pliers, 8" L  
**TJZ090** Locking Pliers, 4" L  
**TJZ091** Locking Pliers, 5" L  
**TJZ092** Locking Pliers, 7" L  
**UAV666** Locking Pliers, 10" L  
**TJZ094** Long Nose Pliers, 4" L  
**UAV667** Long Nose Pliers, 6.5" L

**TJZ096** Locking Pliers, C-clamp, 6" L  
**UAV668** Locking Pliers, C-clamp, 11" L  
**TJZ099** Locking Pliers, Sheet Metal, 8" L  
**TJZ100** Adjustable Wrench, 6" L  
**TJZ101** Adjustable Wrench, 8" L  
**TJZ102** Adjustable Wrench, 10" L  
**TJZ103** Adjustable Wrench, 12" L  
**TJZ104** Adjustable Wrench, 15" L  
**TJZ105** Adjustable Wrench, 18" L  
**TJZ108** Pipe Wrench, 12" L  
**TJZ110** Pipe Wrench, 18" L  
**TLV055** Combination Wrench Set, S.A.E.  
**TLV056** Combination Wrench Set, Metric  
**TJZ112** Bolt Cutters  
**TLV361** Socket Set, S.A.E./Metric  
**TLZ420** Chisel Set  
**TLZ421** Pin Punch Set  
**TLZ422** Drift Punch Set  
**TLZ423** Centre Punch Set  
**TNB733** Hex Key Set, S.A.E.  
**TJZ110** Hex Key Set, Metric  
**TYB504** C-clamp, 4" Jaw Width  
**TYB506** C-clamp, 8" Jaw Width  
**TYB508** C-clamp, 12" Jaw Width  
**XC488** Extension Cord 25' L  
**XE887** LED Headlamp  
**XJ059** LED Flashlight

# VICES & CLAMPS

Vises .....	53, 54
Hold Down Clamps .....	55
Latch Clamps .....	55
Straight Line Clamps .....	55
C-clamps .....	56

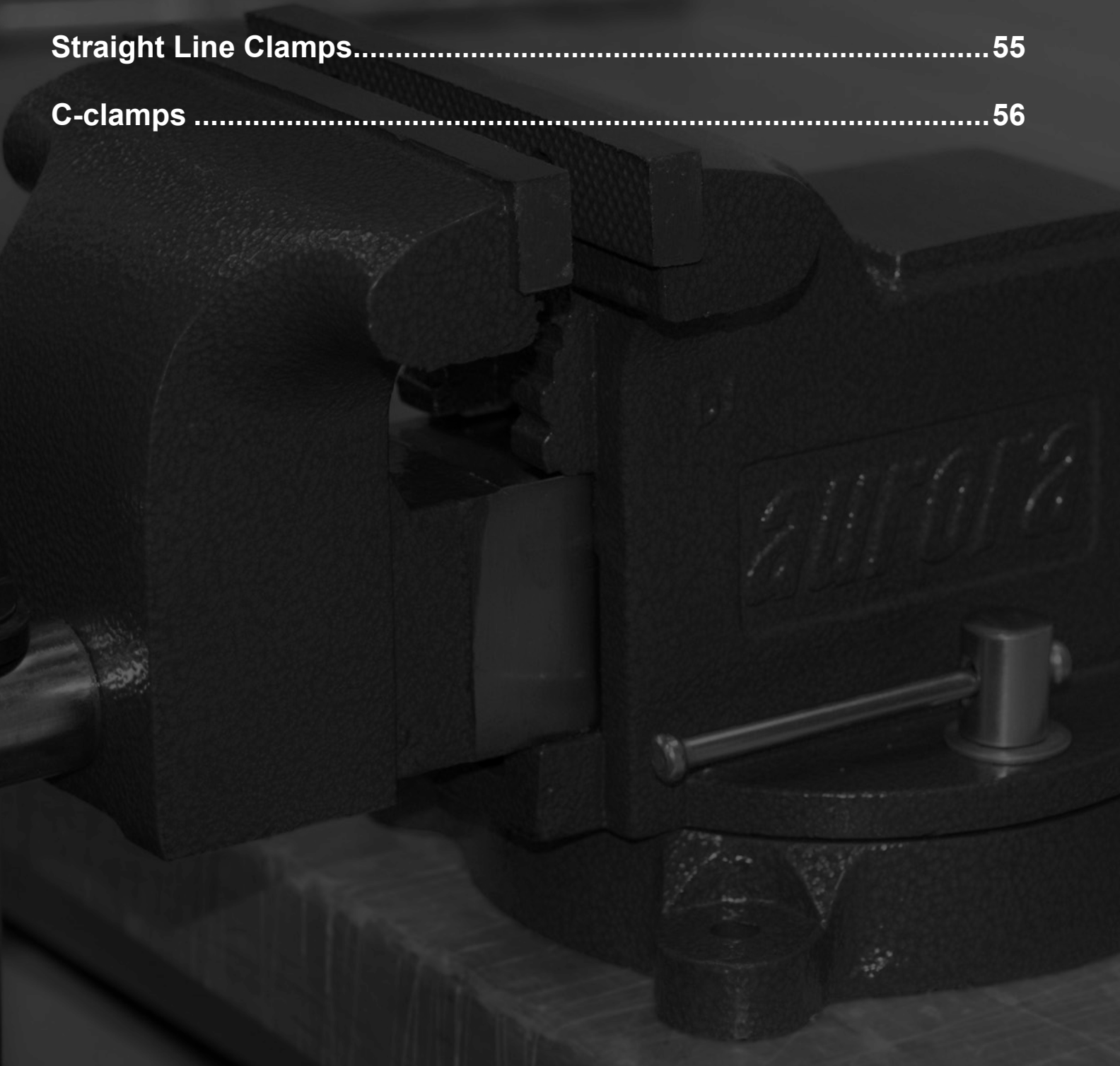

## ▶ HEAVY-DUTY BENCH VISES

- 80 000 PSI industrial grade ductile iron
- Built in pipe jaws hold round objects
- Hardened anvil striking surface used for forming & shaping
- Safety locking plate in base prevents the vise from slippage

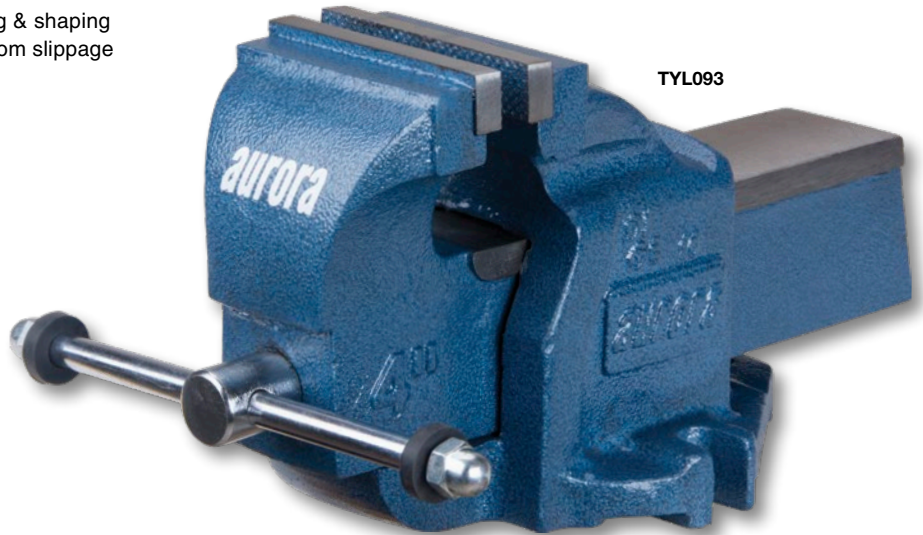

TYL093



TYL098

Model No.	Jaw Width"	Jaw Opening"	Throat Depth"	Mount Type
TYL093	4	4-1/2	2-7/10	Fixed
TYL094	5	5-1/2	3-3/10	Fixed
TYL095	6	6-1/2	3-1/2	Fixed
TYL096	8	8-1/2	4	Fixed
TYL098	4	4-1/2	2-1/2	Swivel
TYL099	5	5-1/2	3	Swivel
TYL100	6	6-1/2	3-4/10	Swivel
TYL101	8	8-3/10	3-8/10	Swivel

## ► MULTI-PURPOSE BENCH VISE

- 80,000 PSI Industrial grade ductile iron
- Rotating head for gripping at any angle
- Permanent pipe jaws hold round objects
- Hardened anvil striking surface used for forming & shaping
- Safety locking plate in base prevents the vise from slippage



Model No.	Jaw Width"	Jaw Opening"	Throat Depth"	Mount Type
TYL102	5	5-1/2	3-1/10	Swivel

## ► OFF-SET BENCH VISE

- 80,000 PSI Industrial grade ductile iron
- V notched hardened jaws for vertical gripping
- Ideal for tall work pieces
- Hardened anvil striking surface used for forming & shaping
- Safety locking plate in base prevents the vise from slippage

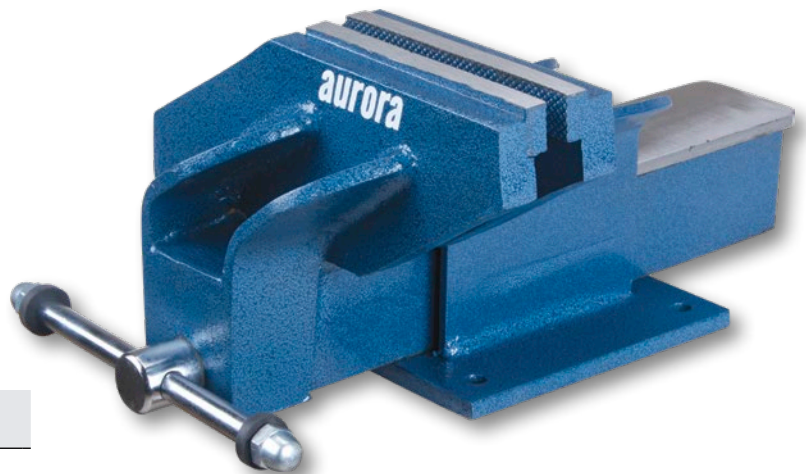

Model No.	Jaw Width"	Jaw Opening"	Throat Depth"	Mount Type
TYL103	6	6-1/2	4	Fixed

## ► UTILITY WORKSHOP VISE

- 80000 PSI industrial grade ductile iron
- Built in pipe jaws hold round objects
- Hardened anvil striking surface used for forming & shaping
- Safety locking plate in base prevents the vise from slippage



Model No.	Jaw Width"	Jaw Opening"	Throat Depth"	Mount Type
TYL097	6	6-1/2	3-4/10	Swivel



## VERTICAL HOLD DOWN CLAMPS

- Includes bonded neoprene-tipped spindle and flanged washers
- Open arm provides adjustable spindle location
- Commonly used clamps in manufacturing
- Perfect for holding work pieces in place
- Durable steel construction

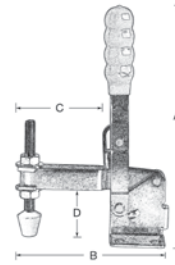

TLV626

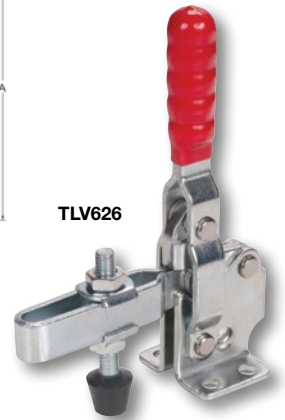

Model No.	Clamping Force lbs.	Dimensions				Base		Wt. lbs.	
		A"	B"	C"	D"	x	W"		
TLV625	200	4	2-1/2	1	1	1	x	1-3/4	0.34
TLV626	375	6	4-5/8	2-3/4	1-1/4	1-13/16	x	1-7/16	0.65
TLV627	600	8-1/8	4-13/16	3	1-3/4	1-7/8	x	2-1/2	1.25

## HORIZONTAL HOLD DOWN CLAMPS

- Includes bonded neoprene-tipped spindle and flanged washers
- Low height design is ideal when space is a concern
- Open arm provides adjustable spindle location
- Commonly used clamps in manufacturing
- Perfect for holding work pieces in place
- Durable steel construction

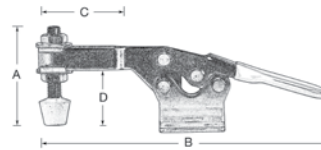

TLV628



Model No.	Clamping Force lbs.	Dimensions				Base		Wt. lbs.	
		A"	B"	C"	D"	L"	x		W"
TLV628	200	1-1/16	5-5/8	2-1/4	1	1-7/16	x	1-7/16	0.28
TLV629	500	1-13/16	6-3/4	2-11/16	15/16	1-3/8	x	1-1/2	0.52

## LATCH CLAMPS

- Commonly used to hold molds, dies, and jigs together
- Includes latch plate
- Commonly used clamps in manufacturing
- Perfect for holding work pieces in place
- Durable steel construction

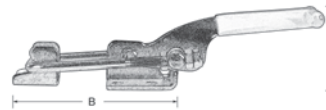

TLV630

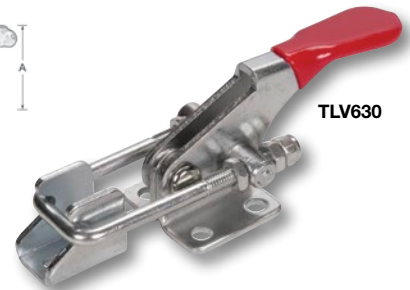

Model No.	Clamping Force lbs.	Dimensions			Base		Wt. lbs.
		A"	B"	L"	x	W"	
TLV630	360	1-1/4	4	1-1/16	x	1	0.16
TLV631	700	1-5/8	6-7/8	1-11/16	x	1-1/2	0.55

## STRAIGHT LINE CLAMPS

- Commonly used in assembly operations or with welding jigs
- Commonly used clamps in manufacturing
- Perfect for holding work pieces in place
- Durable steel construction

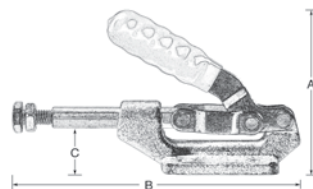

TLV632

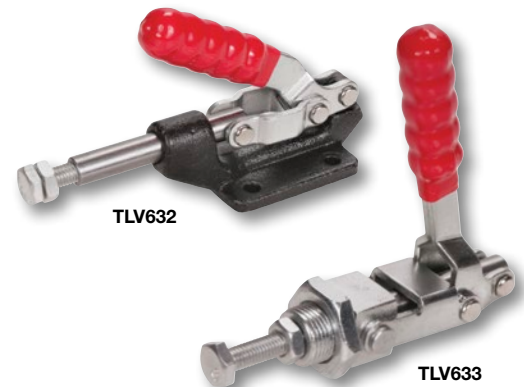

TLV633

Model No.	Clamping Force lbs.	Dimensions				Base		Wt. lbs.
		A"	B"	C"	L"	x	W"	
TLV632	600	3-1/8	5-1/4	1-1/2	1-7/8	x	2-1/4	0.80
TLV633	300	4-5/16	4-1/2	-	-	-	-	0.42

## PARALLEL JAW CLAMPS

- Aluminum die-cast handles have a quick adjustment mechanism for easy sizing
- Serrations in the steel rails engage with a hardened steel insert in the jaw to eliminate slipping
- Clamp jaws are encased in non-marring, glue resistant polypropylene casing
- Clamps up to 2.5 KN of pressure
- Throat depth: 3-1/3"
- Throat width: 1-1/2"
- Clamping Force: 562 lbs

Model No.	Clamping Capacity"
TYB500	24
TYB501	40



## C-CLAMPS

- Manufactured from SG iron with over 60 000 PSI of tensile strength
- Swiveling pad adapts to the correct angle to apply even pressure on the work piece
- Textured powder coat finish on frame and black oxide finish on spindle increases corrosion resistance

Model No.	Clamping Capacity"	Throat Depth"	Clamping Force (lbs)
TYB502	2	1-5/8	800
TYB503	3	1-11/16	1000
TYB504	4	2-11/32	1200
TYB505	6	3	1400
TYB506	8	3-1/8	1700
TYB507	10	3-1/2	2200
TYB508	12	4	2500



# LUBRICATION TOOLS

<b>Grease Guns .....</b>	<b>58,59</b>
<b>Suction Gun .....</b>	<b>59</b>
<b>Grease Pump .....</b>	<b>60</b>
<b>Grease Gun Accessories .....</b>	<b>61,62</b>
<b>Grease Fittings .....</b>	<b>63</b>
<b>Oil Cans &amp; Funnel.....</b>	<b>64</b>

## STANDARD-DUTY LEVER GREASE GUN

- Designed for use in general lubrication and daily maintenance work
- Capacity: 14 oz. (400 g) grease cartridge or suction fill
- Comes with 6" steel extension and 4-jaw coupler with ball check
- Develops 6000 PSI

Model No. AC472



## HEAVY-DUTY LEVER GREASE GUN

- Designed for punishing day-in and day-out heavy industrial applications
- Capacity: 14 oz. (400 g) grease cartridge, filler pump or suction fill
- Built-in variable stroke feature for greasing fittings with limited access
- Die cast grease gun head fitted with bulk loader and air bleeder
- Extra heavy-duty zinc plated lever handle with ergonomic rubber grip
- Comes with 6" steel extension and 4-jaw coupler with ball check
- Develops 10000 PSI

Model No. AC473



## HEAVY-DUTY PISTOL GREASE GUNS

- Designed for use in general confined spaces or where access to grease nipples is restricted
- Capacity: 14 oz. (400 g) grease cartridge or suction fill
- Heavy-duty die cast grease gun head
- Develops 5000 PSI
- Comes with a 4-jaw coupler with ball check



Model No.	Includes
AC475	5" steel extension
AC476	18" flexible hose

## ▶ DELUXE MINI PISTOL GREASE GUN

- Die cast grease gun head with dual discharge ports for use with steel extension as well as a flex hose
- Single-hand operated pistol grip
- Develops 3500 PSI
- Capacity: 3 oz. grease cartridge or bulk fill
- Textured zinc plated finish for non-slip grip
- Comes with 4" steel extension and professional 4-jaw coupler with ball check

Model No. AC477

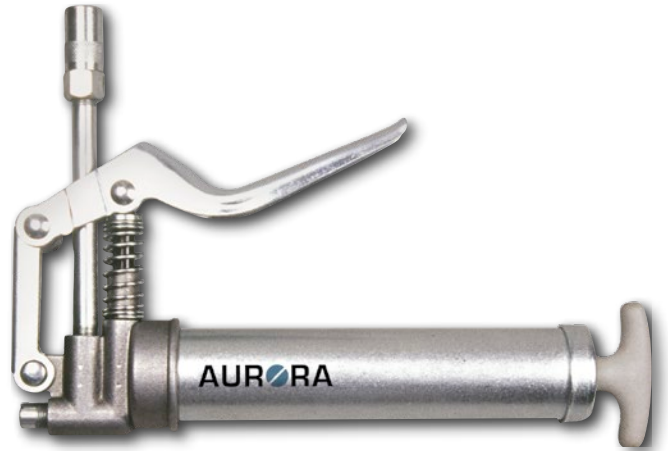

## ▶ AIR-OPERATED GREASE GUN

- Ideal for use in factory maintenance
- Single shot of grease discharge with every press of the trigger
- Air operating range: 40 - 120 PSI
- Comes with 6" steel extension and professional 4-jaw coupler with ball check
- Cartridge Capacity: 414 ml
- Max. PSI 4800 PSI

Model No. AC478



## ▶ MINI GREASE GUN

- Designed for use in general confined spaces, or where access to grease nipples is restricted
- Single-hand-operated push type grip
- Develops 1400 psi
- Capacity: 3 oz. (85 g)

Model No. AD084



## ▶ SUCTION GUN

- A rugged transfer gun designed for use with gear oils to get them both into and out of gear boxes, transfer cases and differentials
- Comes with 12" flexible vinyl hose
- Capacity: 16 oz.

Model No. AC494



## GREASE FILLER PUMP

- An ideal grease filling solution to easily load bulk or combination grease guns from bulk grease pails
- No mess or waste
- Full economy in buying bulk grease
- Fits gallon size: 5 gallons
- Rubber lining follower plate for use with most bucket type

Model No. AD383



## BUCKET GREASER

- High-volume, high-pressure grease pump
- Uses low cost bulk grease
- Delivers 3 g/stroke or 1 oz. in less than 10 strokes at pressures up to 2000 PSI
- Comes with 22-lb. built-in steel grease bucket

Model No. AC495



## AIR-OPERATED GREASE PUMPS

- Ideal for applications having continuous need for high-pressure grease
- Pump ratio 50:1
- Recommended air pressure between 60 and 125 PSI
- Air inlet: 1/4" NPT (female)
- Grease outlet: 1/4" NPT (female)
- Fits 5-gallon and 16-gallon pails
- Rubber-lined follower plate, 7' of high pressure grease hose, Z swivel and grease control valve
- Develops: 6250 PSI

Model No. AC496

- 25-50 lbs. Pails
- 12" diameter drum cover

Model No. AC497

- For 120 lbs. Pails
- 15" diameter drum cover



## PREMIUM GREASE CONTROL VALVE

- For use with power-operated equipment
- Provides continuous grease flow with trigger fully depressed
- Inlet thread specification: 1/4" NPT (female)
- Outlet thread specification: 1/8" NPT (female)
- 7500 PSI
- Comes with 6" steel extension and heavy-duty coupler

Model No. AC498



## ▶ PROFESSIONAL COUPLER

- Hardened spring steel jaws and hardened body withstand high pressures without deformation
- Hexagonal nut allows easy tightening
- Threads: 1/8" NPT
- 4-jaw construction, 6000 PSI
- For hand-operated grease guns only

Model No. AC482



## ▶ HEAVY-DUTY COUPLER

- Hardened spring steel jaws and hardened body with double-wall thickness withstand very high pressures without deformation
- Hexagonal nut allows easy tightening
- Threads: 1/8" NPT
- 4-jaw construction, 10 000 PSI
- For hand and air operated equipment

Model No. AC483



## ▶ 360° SWIVEL HYDRAULIC COUPLER

- Excellent coupler for effective lubrication of difficult and hard-to-reach grease fittings
- Swivels in full 360° circle and locks conveniently at any 45° position
- 45° angle gives easy access to most grease fittings
- Spring-loaded ball-check valve helps retain pressure
- Threads: 1/8" NPT
- 3-jaw construction, 7000 PSI

Model No. AC484



## ▶ RIGHT-ANGLED HYDRAULIC COUPLER

- Fits all standard grease guns
- Designed for right-angled discharge of grease, very useful for greasing fittings with limited access or in low heights
- Threads: 1/8" NPT
- 10 000 PSI

Model No. AC485



## ▶ FLEXIBLE GREASE HOSES

- Standard grease hose is the most popular version of flexible grease hoses
- Threads: 1/8" NPT
- Working pressure: 3500 PSI
- For hand-operated grease guns only
- **AC481** hose fitted with heavy-duty spring guard adds safety and convenience in fitting, as well as preventing the hose from bending

Model No.	Length"
AC479	12
AC480	18
AC481	18



## ▶ SEAL-OFF DISPENSER

- Used with grease gun extension or hose for lubricating grease plugs
- Threads: 1/8" NPT

Model No. AC491



## ▶ STEEL BEARING PACKER

- For use with grease guns
- The design incorporates a grease nipple at one end which easily adapts to the diameter grease gun coupler
- Greases bearings in cars, boats, trailers, RV's etc. with a minimum inner diameter of 1/2" to a maximum outer diameter of 5" and height from 1/4" to 2"

Model No. AC493



## ▶ GREASE GUN HOLDER

- Simple snap action clamp for safe storage of grease guns and suction guns
- Fits all standard grease guns

Model No. AC486



## ▶ GREASE INJECTOR NEEDLE

- Lubricates in very tight spaces such as universal joints and sealed bearings
- Equipped with standard grease fitting without ball check and protective plastic holder
- 18-gauge needle thickness
- 1-1/2" long

Model No. AC487



## ▶ NEEDLE NOSE ADAPTOR

- Used for dispensing a fine line of grease through the needle nose
- Quick-connect action
- Tip diameter: 0.046" (1.168 mm)
- Needle length: 4"

Model No. AC488



## ▶ NEEDLE NOSE DISPENSERS

- Used for dispensing a fine line of grease
- Can be attached directly to steel extensions or flexible hoses
- Threads: 1/8" NPT

Model No.	Needle Length	Needle Diameter"
AC489	15 mm	0.219
AC490	38 mm	0.156



## ▶ EZEE-LUBE KIT

- The Ezee-Lube kit contains a range of quick-connect fittings designed to meet any and every greasing application

Model No. AC492



## ▶ EASY-OUT TOOLS

- Handy, dual-purpose tool for removing worn and broken grease fittings, as well as re-tapping holes for installing new grease fittings

Model No.	Tap Rethreads
AC511	1/4"-28
AC512	1/8"-27





## SWIVELS

- Installed between the delivery hose and grease control valve, swivels permit easy handling of control valves and prevent damage to hose caused by twisting
- 6000 PSI

Model No.	NPT (F)	NPT (M)
AC499	1/4"	1/4"
AC500	1/4"	1/8"

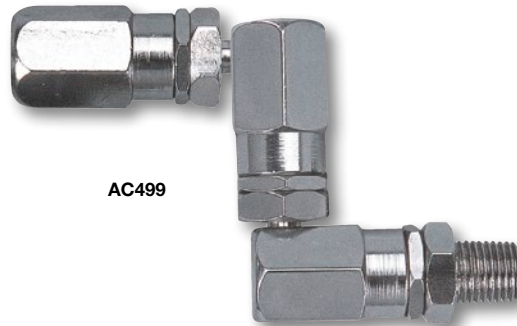

AC499

## GREASE FITTINGS

- Manufactured to the most stringent quality standards
- QS9000 Approved



AC501



AC504



AC507

### S.A.E.

Model No.	Description
<b>1/4" - 28 S.A.E.-LT PIPE THREADS - SET OF 10</b>	
AC501	Short - Straight
AC502	Short - 45°
<b>1/8" - 27 NPT PIPE THREADS - SET OF 10</b>	
AC504	Short - Straight
AC505	Short - 45°
AC506	Short - 90°

### METRIC

Model No.	Description
<b>M6 X 1 PIPE THREADS - SET OF 10</b>	
AD202	Straight
AD203	90°
<b>M8 X 1 PIPE THREADS - SET OF 10</b>	
AD204	Straight
AD205	90°
<b>M10 X 1 PIPE THREADS - SET OF 10</b>	
AD206	Straight
AD207	90°

## GREASE FITTING SETS



### SETS

Model No.	Contents
<b>AC509</b>	<b>80 PCS. OF S.A.E. GREASE FITTINGS:</b> 15x 1/4" 28 S.A.E. LT Straight 10x 1/4" 28 S.A.E. LT 45° Angle 10x 1/4" 28 S.A.E. LT 90° Angle 25x 1/8" 27 NPT Straight 10x 1/8" 27 NPT 45° Angle 10x 1/8" 27 NPT 90° Angle
<b>AC510</b>	<b>80 PCS. OF METRIC GREASE FITTINGS:</b> 20x M6 x 1 Straight 10x M6 x 1 90° Angle 15x M8 x 1 Straight 10x M8 x 1 90° Angle 15x M10 x 1 Straight 10x M10 x 1 90° Angle

### OIL CANS

- Seamless oil can body is drawn from heavy-gauge tin-coated sheet
- Premium powder-coated finish
- Steel pump



AC588



AC597



AC590

Model No.	Cap. Oz.	Spout Length"	Spout Type
<b>PISTOL TYPE</b>			
AC588	4	5	Flexible
AC513	6	5	Flexible
AC597	6	6	Flexible
AC596	6	6	Rigid
AC599	16	6	Flexible
AC598	16	6	Rigid
AC600	33	6	Rigid

Model No.	Cap. Oz.	Spout Length"	Spout Type
<b>LEVER TYPE</b>			
AC514	6	6	Flexible
AC515	10	6	Flexible
AC589	13	7	Flexible
AC516	16	7	Flexible
AC592	16	9	Flexible
AC593	16	9	Rigid
AC590	23	8	Flexible
AC594	33	9	Flexible
AC595	33	9	Rigid

### LIQUID MEASURES

- Translucent high density polyethylene construction
- Comes complete with a polyethylene flexible spout for difficult to reach areas
- Cap on flexible spout and polypropylene lid renders measure spill proof
- Spout length: 7-1/2"
- Spout diameter: 3/4"



Model No.	Cap. Quart
TYB513	1
TYB514	2
TYB515	3
TYB516	5

### FUNNELS

- Translucent high density polyethylene construction
- Wire mesh screen keeps contaminants out
- Comes complete with a polyethylene flexible spout for difficult to reach areas
- Curved funnel ends make the funnel splash and spill proof



Model No.	Diameter"	Capacity Litres
TYB517	8	1.7
TYB518	9-1/2	3

# PAINTING SUPPLIES & TAPES

Paint Brushes .....	66, 67
Roller Frame.....	67
Paint Roller Sleeve .....	67
Drop sheet.....	67
Empty Paint Cans .....	67
Sealing Spatulas .....	68
Hand Pads .....	68
Painter's Masking Tape .....	69
Masking Tape .....	69
Teflon Sealing Tape .....	69
Aluminum Foil Tape .....	69
Electrical Tape .....	69

## POLYESTER BRISTLES PAINT BRUSHES

- Solid plastic handle
- Tin-plated ferrule
- Well-suited for latex-based paints
- Brush thickness: 1/4"



KP308



KP307

Model No.	Width"
KP307	1
KP308	2
KP765	3
KP766	4

## NATURAL BRISTLES PAINT BRUSHES

- Solid plastic handle
- Tin-plated ferrule
- Well-suited for oil-based paints



KP301

Model No.	Width"	Thickness"
KP300	1	9/16
KP301	2	5/8
KP302	3	5/8
KP303	4	5/8

## AP200 SERIES PAINT BRUSH SET

- Brush widths: 1/2", 1", 2", & 3"
- White China bristles
- Tin-plated ferrule
- Well-suited for oil-based paints
- Wood handle



Model No. KP854

## WHITE CHINA BRISTLES PAINT BRUSHES

- Solid plain wood handle
- Tin-plated ferrule
- Well-suited for oil-based paints



KP297



KP306

Model No.	Width"	Thickness"
KP306	1/2	5/16
KP297	1	3/8
KP298	2	3/8
KP299	3	3/8

## AP100 SERIES PAINT BRUSH SET

- Brush widths: 1", 2", 3" & 4"
- Tin-plated ferrule
- Well-suited for latex-based paints
- 100% black polyester bristles
- Plastic handle

Model No. KP853



## AP300 SERIES PAINT BRUSH SET

- Brush widths: 1", 2", 3" & 4"
- Tin-plated ferrule
- Well-suited for latex-based paints
- Natural bristles
- Plastic handle

Model No. KP855



## ▶ ROLLER FRAME

- Heavy-duty 5-wire gauge
- Handle Material: Plastic
- Roller Length: 9-1/2"
- Shank Material: Metal

Model No. UAV348



## ▶ MULTI-USE PAINT ROLLER SLEEVE

- Designed for smooth surfaces
- Length: 230 mm (9")
- Sleeve Material: Polyester Fibre
- Core Material: PP (Polypropylene)
- Core Diameter: 1-1/2"
- Application Type: Oil and Latex Paints



KP726

Model No.	NAP" (mm)	Surface
KP726	1/4 (6)	Smooth
KP727	3/8 (9.525)	Semi-Smooth

## ▶ AP400 SERIES PAINT BRUSHES

- Foam brush
- Solid wood handle
- Disposable
- Well-suited for applying urethane or for touch-up jobs
- Brush width: 1"



KP304

Model No.	Description	Thickness"
KP335	Premium	1

## ▶ DROP SHEET

- Can be used to protect floors and furniture during renovations
- Includes: Drop sheet, Cutter
- Resists bleed through
- Strong and lightweight
- Easy to tape
- Length: 400'
- Width: 9'
- Material: Plastic



Model No. KQ208



KQ208

## ▶ EMPTY PAINT CANS

- Material: Metal
- Can Design: Plain
- Ideal for storing paints, coatings, and stains
- Features cover and handle for easy pouring, transport, and storage
- Tight-seal lid

Model No.	Capacity
KP922	1 US Gal. (3.78L)
KP923	0.25 US Gal. (946 ml)
KP924	0.125 US Gal. (473 ml)

KP924



KP923



KP922



## SEALING SPATULAS

- Ideal for spreading or removing sealant and adhesives
- Manufactured with fibreglass reinforced plastic
- Exceptional durability
- Flexible tips



Model No.	Length"	Large Tip Width"	Small Tip Width"	Qty /Pkg
TLV164	7-1/2	1/4	1/8	5
TLV568	7-1/4	1/2	3/8	4

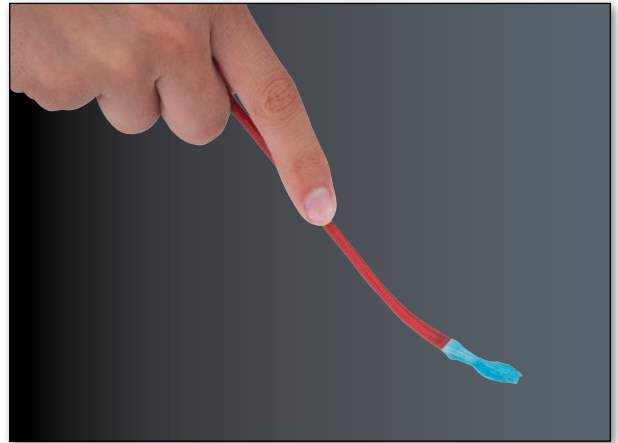

## HAND PADS

- Non-woven, synthetic fibres, bonded together with specially formulated resins and impregnated throughout the web with mineral grain creating an open, three dimensional structure
- Designed for light-duty cleaning, polishing, scuffing, finishing and for heavy-duty paint, rust and corrosion removal
- Can be used for dry scuffing and finishing or may be used with water or chemical solvents
- Flexible and strong
- 6" x 9"

Model No.	Description	Finish	Case Qty
NU022	Tan Heavy-Duty	Coarse	10
NU023	Green Industrial	Scouring	20
NU024	Maroon General Purpose	Medium	20
NU025	Grey Ultra-Fine	Ultra-Fine	20
NU026	White Non-Abrasive	Non-Abrasive	20

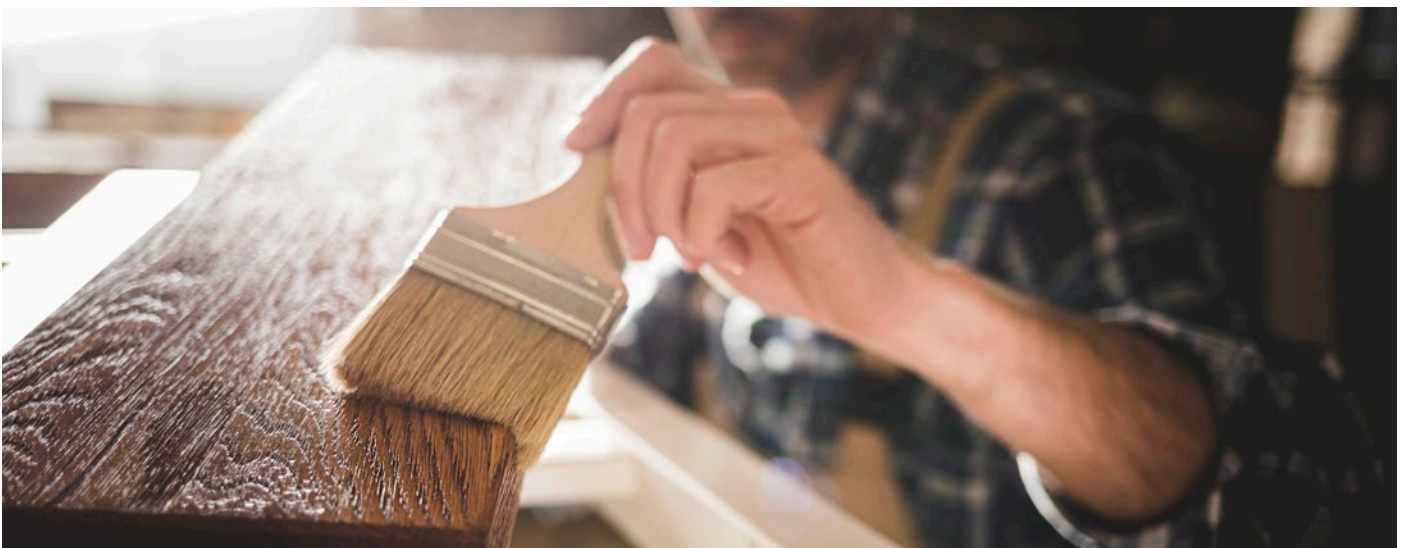

## ▶ PAINTER'S MASKING TAPE

- High quality painting tape adheres to multiple surfaces
- Reliable adhesion resists paint bleed-through
- Removes cleanly in one piece
- Length: 180' (55 m)
- Colour: Green



PF690

Model No.	Width
PF690	1" (25 mm)
PF691	2" (50 mm)

## ▶ GENERAL PURPOSE MASKING TAPE

- Designed for all general purpose masking projects offering a good adhesion to a wide variety of surfaces
- Resists lifting or curling
- Removes easily and cleanly
- Length: 180' (55 m)
- Colour: Beige



PF886

Model No.	Width
PF886	3/4" (19 mm)
PF887	1" (25 mm)
PF888	2" (50 mm)

## ▶ TEFLON SEALING TAPE

- Commonly used in plumbing for sealing pipe threads
- Ensures a tight seal: Works for both water and air
- Colour: White
- Tape Material: PTFE
- Thickness: 3 mils (0.0762mm)
- Density: 0.37 grams/cubic centimeter
- Working Temperatures Range: -190°C to 260°C (-310°F to 500°F)



PG148

Model No.	Width"	Length"
PG148	1/2	520
PG149	3/4	520

## ▶ ALUMINUM FOIL TAPE

- For general purpose use (seaming, patching and sealing)
- Acrylic adhesive has excellent adhesion and permanently bonds to clean/dry surfaces
- Ideal for HVAC applications
- Temperature Resistance: -20 °C to 120 °C



PG176

Model No.	Width"	Length'	Thickness mils.
PG176	1-7/8"	150'	1.5
PG177	3"	150'	1.5
PG178	1-7/8"	180'	2
PG179	3"	180'	2
PG180	1-7/8"	180'	4.8

## ▶ ELECTRICAL TAPE

- Width: 3/4" (19 mm)
- Length: 60' (18 m)
- Material: Vinyl Plastic
- Thickness: 7 mils
- Electrical tape for splicing and insulating wires
- For use between -7°C and 80°C
- CSA approved

Model No.	Colour
XE890	Black
XH383	Red
XH384	Green
XH385	Blue
XH386	White
XH387	Yellow

XE890



XH384



XH386



XH383



XH385



XH387

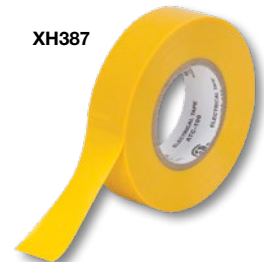

# AIR TOOLS

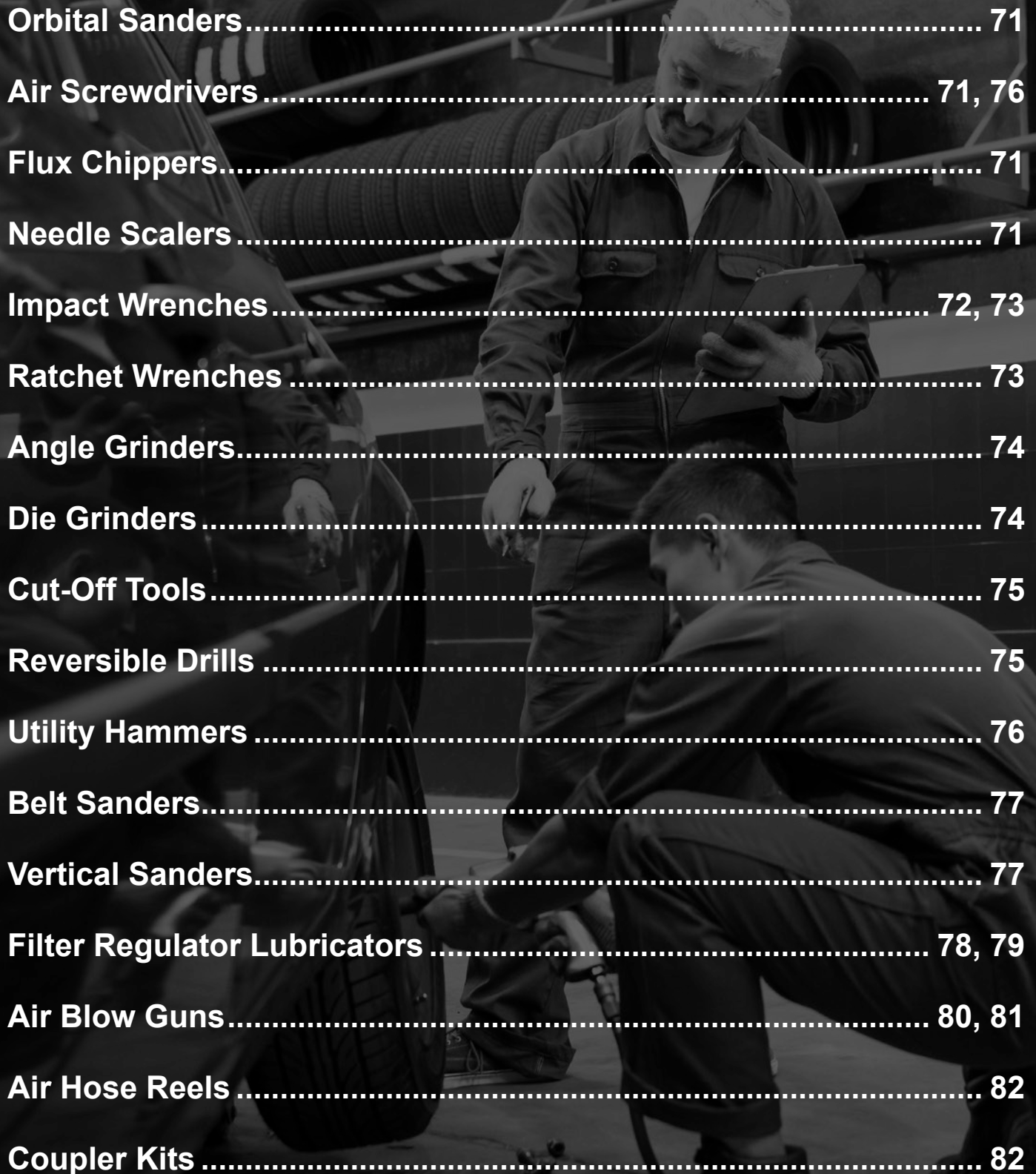

<b>Orbital Sanders</b> .....	<b>71</b>
<b>Air Screwdrivers</b> .....	<b>71, 76</b>
<b>Flux Chippers</b> .....	<b>71</b>
<b>Needle Scalers</b> .....	<b>71</b>
<b>Impact Wrenches</b> .....	<b>72, 73</b>
<b>Ratchet Wrenches</b> .....	<b>73</b>
<b>Angle Grinders</b> .....	<b>74</b>
<b>Die Grinders</b> .....	<b>74</b>
<b>Cut-Off Tools</b> .....	<b>75</b>
<b>Reversible Drills</b> .....	<b>75</b>
<b>Utility Hammers</b> .....	<b>76</b>
<b>Belt Sanders</b> .....	<b>77</b>
<b>Vertical Sanders</b> .....	<b>77</b>
<b>Filter Regulator Lubricators</b> .....	<b>78, 79</b>
<b>Air Blow Guns</b> .....	<b>80, 81</b>
<b>Air Hose Reels</b> .....	<b>82</b>
<b>Coupler Kits</b> .....	<b>82</b>



## DUAL-ACTION ORBIT SANDERS

- Dual-action, compact and lightweight design
- Lever throttle offers one-hand control
- Low vibration for swirl-free finishes
- Non-vacuum model
- Free speed: 10000 RPM
- Average Air Consumption: 9 CFM
- Hose air inlet: 1/4" - 18 NPT
- Units come with a stick-on pad
- Hose size: 3/8" (9.5 mm)
- Horse power: 0.35 HP
- Vibration less than 0.80 m/s<sup>2</sup>
- Sound pressure Level: 78 (dBA)



### SANDER

Model No.	Dia."	Overall Length"	Weight lbs.
TLZ142	5	6-1/2	1.8
TLZ143	6	7	1.9

### SANDER PADS

Model No.	Description
TLZ472	Stick-on Pad For TLZ142
TLZ473	Hook-up Pad For TLZ142
TLZ474	Stick-on Pad For TLZ143
TLZ475	Hook-up Pad For TLZ143

## 1/4" AIR SCREWDRIVER

- Durable steel body
- Forward-reverse switch
- Low noise, low vibrations
- Overall length: 7-1/2"
- Weight: 2.4 lbs.
- Horse power: 0.5 HP



Model No.	Free Speed RPM	Torque Range ft-lbs.	Average Consumption CFM	Air Inlet	Hose Size	Vibrations Less Than m/s <sup>2</sup>	Sound Pressure Level (dBA)
TLV495	1800	3.75-9.5	6	1/4" - 18 NPT	3/8" (9.5 mm)	0.7	82

## AIR FLUX CHIPPER

- Lightweight and compact design permits increased operator efficiency
- Paddle style trigger offers better speed control and precision
- Low noise, low vibration
- Durability and longer life
- Comes with 35 mm flat chisel
- Overall length: 10-1/4"
- Weight: 4.1 lbs.

### AVAILABLE ACCESSORIES:

20 mm flat chisel - **Model No. TLZ134**

35 mm flat chisel - **Model No. TLZ135**

Moil point - **Model No. TLZ136**



## AIR NEEDLE SCALER

- Lightweight compact design permits increased operator efficiency
- Paddle style trigger offers better speed control and precision
- Low noise, low vibration
- Durability and longer life
- Comes with 19 needles
- Overall length: 16"
- Weight: 6.1 lbs.

### REPLACEMENT NEEDLES:

7" Long, 19/pack - **Model No. TLZ132**



Model No.	Description	Stroke	Blows per min. BPM	Average Consumption CFM	Air Inlet	Hose Dia.	Vibrations Less Than m/s <sup>2</sup>	Sound Pressure Level (dBA)
TLZ133	Air Flux Chipper	1-1/2" (38 mm)	4400	9	1/4" - 18 NPT	3/8" (9.5 mm)	10.2	92
TLZ131	Air Needle Scaler	1-1/2" (38 mm)	4000	9	1/4" - 18 NPT	3/8" (9.5 mm)	10.2	104.3

## ▶ 3/4" HEAVY-DUTY AIR IMPACT WRENCH

- Twin hammer impact mechanism
- Three-step forward/reverse regulator allows the operator to adjust the power to the job
- Rear exhaust directs air away from work piece and operator
- Ergonomically designed to reduce operator fatigue
- Special heat-treatment of major parts and anvil for long life
- Soft rubber grip handle reduces fatigue
- Weight: 11 lbs.

Model No. THZ672

## ▶ 1/2" HEAVY-DUTY AIR IMPACT WRENCH

- Pin-clutch hammer mechanism
- Built-in regulator to prevent over-torquing
- Low noise, low vibration
- Forward-reverse switch, and high-low speed regulator
- Durability and longer life
- Weight: 5 lbs.

Model No. UAK133



Model No.	Square Drive	Bolt Capacity	Free Speed RPM	Torque Range ft-lbs.	Average Air Consumption CFM	Air Inlet	Hose Dia.	Vibrations Less Than m/s <sup>2</sup>	Sound Pressure Level (dBA)
THZ672	3/4" (19 mm)	1" (25.4 mm)	4600	565-1100	9	1/4" - 18 NPT	3/8" (9.5 mm)	6.1	90
UAK133	1/2" (12.7 mm)	5/8" (15.9 mm)	7000	25-320	12	1/4" - 18 NPT	3/8" (9.5 mm)	3.1	94

## ▶ HEAVY-DUTY AIR IMPACT WRENCHES

- Ergonomic composite handle helps reduce operator fatigue and insulate vibration
- Exhaust air outlet directs air away from operator
- Forward-reverse switch, and high-low speed regulator
- Low noise, low vibration
- Air Inlet: 1/4" - 18 NPT
- Free Speed RPM: 10,000



Model No.	Square Drive	Bolt Capacity	Overall Length"	Torque Range ft-lbs.	Average Air Consumption CFM	Weight lbs.	Hose Dia.	Vibrations Less Than m/s <sup>2</sup>	Sound Pressure Level (dBA)
TLZ137	3/8" (9.53 mm)	1/2" (13 mm)	7"	90-280	10.6	2.8	3/8" (9.5 mm)	3.7	91.5
TLZ138	1/2" (12.7 mm)	5/8" (16 mm)	7-3/4"	400-1000	13.7	4.6	3/8" (9.5 mm)	6.0	94

## ▶ 3/4" HEAVY-DUTY AIR IMPACT WRENCH

- Ergonomic composite handle and body helps reduce operator fatigue and insulate vibration
- Exhaust air outlet directs air away from operator
- Forward-reverse switch, and high-low speed regulator
- Overall length: 8"
- Weight: 5 lbs.



Model No.	Square Drive	Bolt Capacity	Free Speed RPM	Torque Range ft-lbs.	Average Air Consumption CFM	Air Inlet	Hose Dia.	Vibrations Less Than m/s <sup>2</sup>	Sound Pressure Level (dBA)
TLZ139	3/4" (19 mm)	1" (26 mm)	9000	450-1000	13.7	1/4" - 18 NPT	3/8" (9.5 mm)	9.2	95.9

## ▶ 1/4" STUBBY TYPE AIR RATCHET WRENCH

- Variable speed, reversible
- Paddle style trigger provides better speed control
- Powerful tool in a compact design
- Composite grip helps reduce operator fatigue and insulate vibration
- Overall length: 6-1/2"
- Weight: 1.4 lbs.



Model No.	Square Drive	Free Speed RPM	Torque Range ft-lbs.	Average Air Consumption CFM	Air Inlet	Hose Dia.	Vibrations Less Than m/s <sup>2</sup>	Sound Pressure Level (dBA)
UAV712	1/4" (6.35 mm)	270	5-25	3	1/4" - 18 NPT	5/16" (8 mm)	1.4	96

## ▶ HEAVY-DUTY AIR RATCHET WRENCHES

- Variable speed, reversible
- Paddle style trigger provides better speed control
- Composite handle helps insulate vibration
- Ideal for automotive and industrial fastener removal and installation work



Model No.	Square Drive Size	Free Speed RPM	Torque Range ft-lbs.	Average Air Consumption CFM	Air Inlet	Hose Dia.	Horse Power HP	Vibration Less Than m/s <sup>2</sup>	Sound Pressure Level (dBA)
THZ671	3/8" (9.5 mm)	175	5-75	3	1/4" - 18 NPT	3/8" (9.5 mm)	0.45	1.0	78
THZ680	1/2" (12.7 mm)	175	5-75	3	1/4" - 18 NPT	3/8" (9.5 mm)	0.45	1.0	83

## ▶ 5" PNEUMATIC ANGLE GRINDER

- 5/8"- 11 UNC spindle
- Powerful twin-chamber motor delivers much higher torque
- Ergonomic grip handle reduces operator fatigue
- Textured non-slip composite grip handle helps reduce vibration
- Side handle and wrenches included
- Weight: 3.1 lbs.



Model No.	Grinding Wheel	Spindle Thread	Free Speed RPM	Average Air Consumption CFM	Air Inlet	Hose Size	Vibrations Less Than m/s2	Sound Pressure Level (dBA)
THZ674	5" (127 mm)	5.8" (15.9 mm)	10000	5	1/4" - 18 NPT	3/8" (9.5 mm)	3.1	83

## ▶ 1/4" PNEUMATIC MINI DIE GRINDER

- Ergonomic composite grip handle helps reduce operator fatigue and vibration
- Power/speed regulator allows for easy RPM adjustment
- Twin-bearing design for smooth operation
- Wrenches included
- Weight: 0.9 lbs.



Model No.	Collet Size	Free Speed RPM	Average Air Consumption CFM	Air Inlet	Hose Size	Horsepower HP	Vibrations Less Than m/s2	Sound Pressure Level (dBA)
THZ678	1/4" (6.4 mm)	25000	3	1/4" - 18 NPT	3/8" (9.5 mm)	0.35	0.1	83

## ▶ 1/4" PNEUMATIC ANGLE DIE GRINDER

- Ergonomic composite grip handle helps reduce operator fatigue and vibration
- Power/speed regulator allows for easy RPM adjustment
- Twin-bearing design for smooth operation
- Wrenches included
- Weight: 1.7 lbs.



Model No.	Collet Size	Free Speed RPM	Average Air Consumption CFM	Air Inlet	Hose Size	Horsepower HP	Vibrations Less Than m/s2	Sound Pressure Level (dBA)
THZ679	1/4" (6.4 mm)	18000	3	1/4" - 18 NPT	3/8" (9.5 mm)	0.45	0.1	80

## ▶ 3" AIR CUT-OFF TOOL

- Ergonomic composite grip handle helps reduce operator fatigue and insulate vibration
- Power/speed regulator allows for easy RPM adjustment
- Twin-bearing design for smooth operation and cut off
- Wrench and Hex Key included to lock/unlock the disc
- Weight: 1.8 lbs.



Model No.	Cutting Wheel	Free Speed RPM	Average Air Consumption CFM	Air Inlet	Hose Size	Horsepower HP	Vibrations Less Than m/s <sup>2</sup>	Sound Pressure Level (dBA)
THZ677	3" (76.2 mm)	21000	3	1/4" - 18 NPT	3/8" (9.5 mm)	0.45	0.2	81

## ▶ 3/8" AIR REVERSIBLE DRILL

- Lightweight composite design minimizes operator fatigue
- Ergonomic grip reduces vibration
- Two-gear structure runs smoothly
- Weight: 2 lbs.

Model No. THZ675



THZ675

## ▶ 1/2" AIR REVERSIBLE DRILL

- Lightweight composite design minimizes operator fatigue
- Ergonomic grip reduces vibration
- Two-gear structure runs smoothly
- Side handle included
- Weight: 3 lbs.

Model No. THZ676



THZ676

Model No.	Chuck Size	Spindle Thread	Free Speed RPM	Average Air Consumption CFM	Air Inlet	Hose Size	Vibrations Less Than m/s <sup>2</sup>	Sound Pressure Level (dBA)
THZ675	3/8" (9.5 mm)	3/8" - 24 Threads	1800	4	1/4" - 18 NPT	3/8" (9.5 mm)	0.10	88
THZ676	1/2" (12.7 mm)	3/8" - 24 Threads	450	4	1/4" - 18 NPT	3/8" (9.5 mm)	0.15	88

## ▶ 1/4" UTILITY HAMMER

- Ideal for structural maintenance and repair
- Head Material: Steel



Model No.	Cold Rivet Capacity	Bore & Stroke	Bore Diameter	Chisel Shank	Air Consumption	BPM	Air Inlet	Overall Length	Sound Level (dBA)
UAG272	1/4" (6.4 mm)	3/4" x 2-5/8" (19.0mm x 66.0mm)	3/4" ID (19.05 mm)	0.401" (Round)	25 CFM	3000	1/4" NPTF	7-1/2" (190 mm)	100

## ▶ 5/16" UTILITY HAMMER

- Ideal for structural maintenance and repair
- Head Material: Steel



Model No.	Cold Rivet Capacity	Bore & Stroke	Bore Diameter	Chisel Shank	Air Consumption	BPM	Air Inlet	Overall Length	Sound Level (dBA)
UAG273	5/16" (7.9 mm)	3/4" x 3-5/8" (19.0mm x 92.0mm)	3/4" ID (19.05 mm)	0.401" (Round)	25 CFM	2200	1/4" NPTF	9-13/16" (250 mm)	100

## ▶ DIRECT DRIVE REVERSIBLE SCREWDRIVER

- Chuck Type: Keyless
- Clutch Type: Direct Drive Reversible
- Handle Style: Pistol grip
- Operation: Trigger start



Model No.	Chuck Size	Torque Range in-lbs.	No Load RPM	Air Consumption	Air Inlet	Air Hose Bore	Length	Weight	Vibration Level	Sound Level (dBA)
UAG274	1/4"	216-312	13000	28 CFM	1/4" NPTF	3/8"	5.6" (142 mm)	1.98 lbs (0.9 kg)	<2.5 m/s <sup>2</sup>	88

## ▶ BELT SANDER

- Ideal for detail work (shaping and finishing)
- Low maintenance motor
- Easy belt changes



Model No.	Belt Size"	No Load RPM	Air Consumption	Air Consumption At Free Speed	Air Inlet	Hose I.D.	Wattage	Power	Weight	Sound Level (dBA)
UAG275	13-3/8	16500	16 CFM	L/s: 6.8	1/4" NPTF	3/8"	373	0.5 HP	1.94 lbs. (0.88 kg)	85

## ▶ BELT SANDER

- Ideal for sanding, blending and smoothing operations in various industries
- Low maintenance motor
- Easy belt changes
- Right hand usage only



Model No.	Belt Size"	No Load RPM	Air Consumption	Air Consumption At Free Speed	Air Inlet	Hose I.D.	Wattage	Power	Weight	Sound Level (dBA)
UAG276	20-1/2 - 3/4	16500	16 CFM	L/s: 6.8	1/4" NPTF	3/8"	373	0.5 HP	1.94 lbs. (0.88 kg)	85

## ▶ VERTICAL SANDER

- Ideal for sanding, blending and smoothing operations in various industries



Model No.	Disk Diameter	Paper Size	Spindle Thread	No Load RPM	Air Consumption	Air Inlet	Net Weight	Vibration m/s <sup>2</sup>	Sound Level (dBA)
UAG277	7"	180 mm	5/8" x 11 UNC	4500	24 CFM	1/4" NPTF	5.25 lbs (2.38 kg)	<2.5	89

## SUGGESTIONS FOR INSTALLING FRL & DRAINS

The filter, regulator, and lubricator should be installed in the order shown in the illustration. Individual take-off lines to the FRL unit and air tool(s) should be from the top of the compressed air line. To trap and expel water, sludge, and other contaminants which may collect on the bottom of the air line, a mechanical drain should be used. Mechanical drains should be installed at low points in the piping system and at the far end of the distribution system.

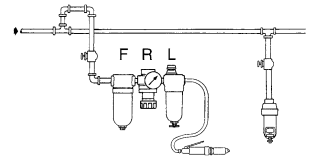

## MODULAR FILTER, REGULATOR & LUBRICATOR (GAUGE INCLUDED)

- Components are attached in series using spacers and piping adapters, which make the individual components easily removable and mountable without disturbing the pipe line
- Comes complete with wall mounting bracket
- Air filter, regulator and lubricator come with NPT threads and gauge
- Operating Pressure: 7-145 PSI

Model No.	Connection Size	Max. Air Flow	Bowl Capacity fl. oz.	Filter Bowl Capacity oz.
<b>POLYCARBONATE BOWL WITH STEEL BOWL GUARD</b>				
TTY181	1/4" NPT	18 SCFM @ 105 PSI	0.68	0.30
TTY182	3/8" NPT	71 SCFM @ 105 PSI	1.93	1.08
TTY183	1/2" NPT	123 SCFM @ 105 PSI	5.17	1.50
<b>METAL BOWL</b>				
TTY184	3/4" NPT	123 SCFM @ 105 PSI	6.8	5.60
TTY185	1" NPT	175 SCFM @ 105 PSI	6.8	5.60



## MODULAR FILTER/REGULATOR & LUBRICATOR (GAUGE INCLUDED)

- Space-saving, two-piece combination is a popular air preparation unit
- Attached in series using spacers and piping adapters, which make the two components easily removable and mountable without disturbing the pipe line
- Come complete with a wall mounting bracket
- Operating Pressure: 7-145 PSI
- Bowl Material: Polycarbonate bowl with steel bowl guard

Model No.	Connection Size	Max. Air Flow	Bowl Capacity fl. oz.	Filter Bowl Capacity oz.
TTY178	1/4" NPT	18 SCFM @ 105 PSI	0.68	0.30
TTY179	3/8" NPT	44 SCFM @ 105 PSI	1.93	1.08
TTY180	1/2" NPT	99 SCFM @ 105 PSI	5.17	1.50



## MODULAR AIR LUBRICATOR

- Used to feed lubricants to pneumatic equipment and maintain a constant oil-to-air density over a wide range of flow
- Fog/Micro Mist type, up to 50' pipe runs
- The head is fitted with oil drop indicator, oil drop controller and oil filling plug
- Designed for best performance with 32-grade oil
- Comes with NPT threads

Model No.	Connection Size	Max. Air Flow	Bowl Capacity fl. oz.	Max. PSI
<b>MODULAR - POLYCARBONATE BOWL W/STEEL BOWL GUARD</b>				
TTY170	1/4" NPT	48 SCFM @ 90 PSI	0.68	145
TTY171	3/8" NPT	106 SCFM @ 90 PSI	1.98	145
TTY172	1/2" NPT	200 SCFM @ 90 PSI	5.13	145
<b>VERTICAL - METAL BOWL</b>				
TTY173	3/4" NPT	255 SCFM @ 90 PSI	6.8	290
TTY174	1" NPT	318 SCFM @ 90 PSI	6.8	290

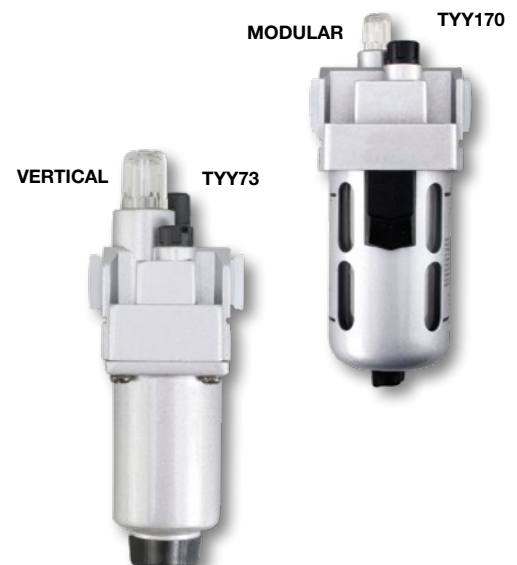



## MODULAR AIR FILTER/REGULATOR (GAUGE INCLUDED)

- Filter-Regulator combination is the most popular air preparation units, assembled together to form a single unit
- Regulators are used to maintain a steady outlet pressure, unaffected by variations or fluctuations in the inlet pressure
- Filter used to separate dust, dirt, moisture and other contaminants from compressed air
- Press-type manual drain with nighttime drain feature, which automatically drains off the bowl once the compressed air supply to the filter is switched off
- Filter has sintered bronze, 40-micron filtering element
- Comes with NPT threads and gauge
- Max. PSI: 145 PSI
- Bowl Material: Polycarbonate bowl with steel bowl guard

Model No.	Connection Size	Max. Air Flow	Bowl Capacity fl. oz.
TTY175	1/4" NPT	20 SCFM @ 105 PSI	0.3
TTY176	3/8" NPT	64 SCFM @ 105 PSI	1.08
TTY177	1/2" NPT	106 SCFM @ 105 PSI	1.5



## MODULAR AIR FILTER

- Used to separate dust, dirt, moisture and other contaminants from compressed air
- Sintered bronze, 40-micron filtering element
- Designed with a separator and shield for efficient moisture separation
- Press-type manual drain with nighttime drain feature, which automatically drains off the bowl once the compressed air supply to the filter is switched off
- Comes with NPT threads
- Drain Type: Semi-Automatic
- Material Filtered: Combination
- Filtration Size (Microns): 40 Microns

Model No.	Connection Size	Max. PSI	Bowl Material
<b>MODULAR</b>			
TTY165	1/4" NPT	145	Polycarbonate
TTY166	3/8" NPT	145	Polycarbonate
TTY167	1/2" NPT	145	Polycarbonate
<b>VERTICAL</b>			
TTY168	3/4" NPT	290	Metal
TTY169	1" NPT	290	Metal



## MODULAR AIR REGULATOR (GAUGE INCLUDED)

- Regulators are used to maintain a steady outlet pressure, unaffected by variations or fluctuations in the inlet pressure
- Regulators step down the air line pressure and can be set at any desired pressure below the inlet air pressure
- Designed with a non-raising "Press to Lock" adjustment knob for locking at any set pressure
- These can be installed in any position and need not be vertically mounted
- Comes with NPT threads and gauge
- Max. PSI: 220 PSI

Model No.	Connection Size	Max. Air Flow
TTY160	1/4" NPT	21 SCFM @ 105 PSI
TTY161	3/8" NPT	88 SCFM @ 105 PSI
TTY162	1/2" NPT	140 SCFM @ 105 PSI
TTY163	3/4" NPT	175 SCFM @ 105 PSI
TTY164	1" NPT	210 SCFM @ 105 PSI



## AIR BLOW GUN WITH BRASS SAFETY NOZZLE

- Contoured design fits comfortably in the operator's hand
- Brass tip increases air flow
- Cushioned thumb lever
- Hook design allows for easy and convenient storage
- 1/4" (F) - 18 NPT Air inlet
- Air Consumption: 29 CFM
- Maximum Working Pressure: 120 PSI

Model No. TLV118



## AIR BLOW GUN

- Contoured body fits comfortably in the operator's hand
- The body is made to protect the palm of the hand against the connection fittings
- Curved tip 5" long
- 1/4" (F) - 18 NPT Air inlet
- Air Consumption: 30 CFM
- Maximum Working Pressure: 120 PSI

Model No. UAV708



## BLOW GUN KIT - 5 PIECES

- Contoured design fits comfortably in the operator's hand
- Chrome plated finish
- Large hanging hook
- 1/4" (F) - 18 NPT Air inlet
- Comes with four tips: safety tip, rubber tip, needle tip, and long needle tip
- Operating Pressure: 90-120PSI

Model No. TLZ147



## HEAVY-DUTY AIR BLOW GUN KIT - 7 PIECES

- Impact and weather resistant nylon body
- Ergonomic soft rubber grip
- Variable speed trigger controls the amount of air dispensed
- Brass threaded air inlet ensures that threads do not shear
- Silent operation with noise level under 80 dB
- 1/4" (F) - 18 NPT air inlet
- Maximum working pressure: 235 PSI
- Operating temperature: -10° C to 70° C

### KIT INCLUDES:

- Heavy-duty safety blow gun w/ 4-1/2" long S.S. nozzle
- 4" protective shield provides safety from projectiles
- Soft rubber star tip nozzle for use on delicate materials
- Venturi nozzle for turbo charging output
- 1/2" rubber tip for blowing out lines and cavities
- 1" rubber tip for blowing out lines and cavities
- 1-3/8" rubber tip for blowing out lines and cavities

Model No. TYB523



- Impact and weather resistant nylon body
- Ergonomic soft rubber grip
- Variable speed trigger controls the amount of air dispensed
- Brass threaded air inlet ensures that threads do not shear

## ▶ HEAVY-DUTY BLOW GUN

- Noise level at 100 PSI: 77 dB
- Standard tip

Model No. TYB519



- Silent operation with noise level under 80 dB
- 1/4" (F) – 18 NPT air inlet
- Maximum working pressure: 50-235 PSI
- Operating temperature: -10° C to 70° C

## ▶ HEAVY-DUTY SAFETY BLOW GUN

- Comes with snub nose rubber tip
- Noise level at 100 PSI: 77 dB
- Standard(s) Met: OSHA STD 1-13.1

Model No. TYB520



## ▶ HEAVY-DUTY SAFETY BLOW GUN W/STAINLESS STEEL NOZZLE

- Comes with 4-1/2" long stainless steel nozzle
- Noise level at 100 PSI: 80 dB
- Standard(s) Met: OSHA STD 1-13.1

Model No. TYB521



## ▶ HEAVY-DUTY SAFETY BLOW GUN W/STAINLESS STEEL NOZZLE & SILENCER

- Comes with 5-1/2" long stainless steel nozzle and a silencer
- Noise level at 100 PSI: 75 dB
- Standard(s) Met: OSHA STD 1-13.1

Model No. TYB522



## HOSE REELS

- Heavy-duty, reinforced steel stampings for increased strength
- Compact design allows reels to fit in tight locations
- Multi-position guide arm for multiple mounting options
- Kinkless, oil resistant high quality hose
- Spring rewind features long life spring with declutching arbour
- Durable, corrosion-resistant powder coat paint
- Good for air and water
- Hose Material: EPDM Rubber

UAV178



Model No.	Drive Type	Hose I.D."	Hose Length'	Max PSI	Hose Outlet" NPTM	Reel Inlet" NPT	Reel Dimensions D" x W" x H"
UAV178	Spring	1/4	35	300	1/4	3/8	8-1/3 x 15 x 17-1/3
UAV179	Spring	3/8	25	300	1/4	3/8	8-1/3 x 15 x 17-1/3
UAV180	Spring	3/8	35	300	1/4	3/8	8-1/3 x 15 x 17-1/3
UAV181	Spring	3/8	50	300	1/4	3/8	8-1/2 x 17-1/2 x 18-7/10
UAV182	Spring	1/2	50	300	1/2	1/2	9-2/3 x 18-1/2 x 21-7/10

## WELDING HOSE REELS

- Heavy-duty, reinforced steel stampings for increased strength
- Compact design allows reels to fit in tight locations
- 1/4" oxygen and acetylene twin hose
- Leak proof double O-ring seals
- Multi-position guide arms for multiple mounting options
- Kinkless, oil resistant high quality hoses
- Spring rewind features long life spring with declutching arbor
- Durable, corrosion-resistant powder coat paint
- Grade R hose

UAV183



Model No.	Drive Type	Hose I.D."	Hose Length'	Max PSI	Oxygen Inlet and Outlet	Acetylene Inlet and Outlet	Reel Dimensions D" x W" x H"
UAV183	Spring	1/4	25	300	9/16" x 18 UNF (Female)	9/16" x 18 UNF (Female)	8-1/3 x 15 x 17-1/3
UAV184	Spring	1/4	50	300	9/16" x 18 UNF (Female)	9/16" x 18 UNF (Female)	8-1/2 x 17-1/2 x 18-7/10

## AIR HOSE NYLON COIL WITH FITTINGS

- Light and easy to handle
- High impact and abrasion resistance
- Excellent elastic memory, can be stretched repeatedly yet return to original shape for convenient storage
- Temperature range: -5°C to 70°C
- Colour: High visibility yellow



Model No.	Hose I.D."	NPT"	Length'	Max. Working Pressure PSI
TLZ150	1/4	1/4	25	200

## 5-PIECE 1/4" PLUG QUICK COUPLER KIT

### SET INCLUDES:

- 1x 1/4" Quick coupler
- 1x 1/4" Female plug
- 3x 1/4" Male plugs

Model No. TLZ148



## 3/8" AIR HOSE REPAIR KIT

### SET INCLUDES:

- 1x Hose Splicer
- 1x Hose End Fitting
- 3x Hose Clamps

Model No. TLZ149



# FACILITY MAINTENANCE

Industrial Wet/Dry Vacuums .....	84, 85
Magnetic Sweepers .....	86

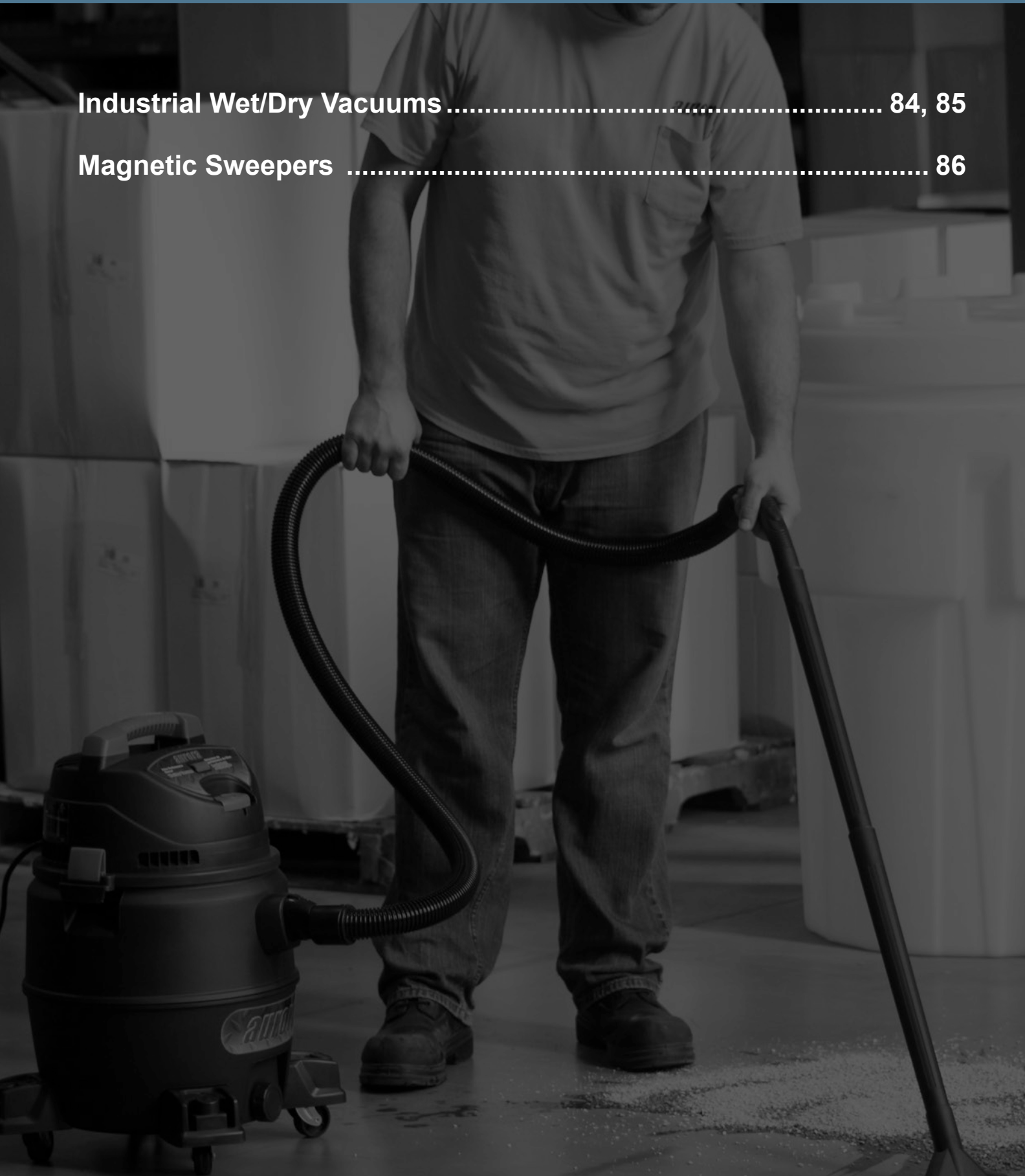

## INDUSTRIAL WET/DRY STAINLESS STEEL VACS

- 8 US gallon (30.2 litres) stainless steel tank
- 6 peak HP motor
- 100 CFM air flow
- Swivel casters provide easy movement in any direction
- Positive lock on hose eliminates unexpected disconnections
- 16' power cord
- **1-7/8" accessories include:** Flexible hose, extension wands, crevice tool, utility nozzle, floor brush, cartridge filter and dust bag

Model No. EB301



## INDUSTRIAL WET/DRY STAINLESS STEEL VACS

- 16 US gallon (60.5 litres) stainless steel tank
- 6 peak HP motor
- 100 CFM air flow
- Heavy-duty rear wheels with swivel front casters provide easy movement
- Removable steel handle
- Positive lock on hose eliminates unexpected disconnections
- Large accessory storage box attached
- 20' Power cord
- **2-1/2" accessories include:** Flexible hose, extension wands, crevice tool, utility nozzle, floor brush, cartridge filter and dust bag

Model No. EB302



## ACCESSORIES & REPLACEMENT PARTS



### 8 GAL. ACCESSORIES & REPLACEMENT PARTS

Model No.	Description	Fits US Gallon Size
JC689	HEPA Cartridge Filter	8 - 16
EB304	Dust Collector Bag 3/Pk	8 - 10
JG726	Extension Wands	8 - 10
JG727	Utility Brush	8 - 10
JG725	6' Flexible Hose	8 - 10
JG729	Floor Brush	8 - 10
JG728	Crevice Tool	8 - 10
JC546	Casters	8 - 10

### 16 GAL. ACCESSORIES & REPLACEMENT PARTS

Model No.	Description	Fits US Gallon Size
JC689	HEPA Cartridge Filter	8 - 16
JC531	Cartridge Filter	8 - 16
JC591	Dust Collector Bag 3/Pk	16
JC541	Extension Wands	16
JC542	Utility Brush	16
JC834	7' Flexible Hose for Ribbed Tank	16
JC545	Crevice Tool	16
JC546	Casters	16

## INDUSTRIAL WET/DRY POLY VACUUM

- Tank Capacity: 8 US Gal. (30.2 Litres)
- Peak HP: 6
- Motor Stage: 1-Stage
- Air Flow: 100 CFM
- Swivel casters provide easy movement in any direction
- Positive lock on hose eliminates unexpected disconnects
- 16' power cord
- **1-7/8" accessories include:** Flexible hose, extension wands, utility nozzle, crevice nozzle, floor brush, cartridge filter and dust bag

Model No. EB299



## INDUSTRIAL WET/DRY POLY VACUUM

- Tank Capacity: 16 US Gal. (60.5 Litres)
- Peak HP: 6
- Motor Stage: 1-Stage
- Air Flow: 100 CFM
- Swivel casters provide easy movement in any direction
- Positive lock on hose eliminates unexpected disconnects
- 16' power cord
- **2-1/2" accessories include:** Flexible hose, extension wands, utility nozzle, crevice nozzle, floor brush, cartridge filter and dust bag

Model No. SDN119



## ACCESSORIES & REPLACEMENT PARTS



### 8 GAL. ACCESSORIES & REPLACEMENT PARTS

Model No.	Description	Fits US Gallon Size
JC689	HEPA Cartridge Filter	8 - 16
EB304	Dust Collector Bag 3/Pk	8 - 10
JG726	Extension Wands	8 - 10
JG727	Utility Brush	8 - 10
JG725	6' Flexible Hose	8 - 10
JG729	Floor Brush	8 - 10
JG728	Crevice Tool	8 - 10
JC546	Casters	8 - 10

### 16 GAL. ACCESSORIES & REPLACEMENT PARTS

Model No.	Description	Fits US Gallon Size
JC689	HEPA Cartridge Filter	8 - 16
JC531	Cartridge Filter	8 - 16
JC591	Dust Collector Bag 3/Pk	16
JC541	Extension Wands	16
JC542	Utility Brush	16
JC834	7' Flexible Hose for Ribbed Tank	16
JC545	Crevice Tool	16
JC546	Casters	16

# MAGNETIC SWEEPERS

- Strong magnet picks up all types of metal debris
- Easy to maneuver
- Quick release pull located on the magnet to disengage
- Can be used on grass, cement, or gravel surfaces
- Heavy-duty design build

Model No.	Width"
UAK048	24
UAK049	36

## ▶ QUICK RELEASE LEVER

- Strong magnet picks up all types of metal debris
- Easy to maneuver
- Quick release pull conveniently located on handle to disengage
- Can be used on grass, cement, or gravel surfaces
- Heavy-duty design build

Model No. UAK050

UAK048



UAK050



UAK049



UAK050



UAK048





# LANDSCAPING

Landscaping Shovels.....	88-91
Spreaders .....	92
Nozzles .....	93
Hoses.....	94
Tarps .....	95

- Durable fiberglass handle with rubber grip
- Forward turned step for extra strength
- 14-gauge tempered steel blade

## DRAIN SPADES

Model No.	Handle Type	Blade Size W" x H"	Overall Length"
NJ096	D-Grip	6 x 16	42-1/2

## SQUARE POINT SHOVELS

Model No.	Handle Type	Blade Size W" x H"	Overall Length"
NJ094	D-Grip	8-1/2 x 11-1/2	42
NJ095	Straight	8-1/2 x 11-1/2	56

## ROUND POINT SHOVELS

Model No.	Handle Type	Blade Size W" x H"	Overall Length"
NJ093	D-Grip	8-1/2 x 11	42
TLZ465	Straight	8-1/2 x 11	56



NJ096

NJ094

NJ095

NJ093

TLZ465

- Durable hardwood handle
- Forward turned step for extra strength
- 14-gauge tempered steel blade

## DRAIN SPADES

Model No.	Handle Type	Blade Size W" x H"	Overall Length"
NN247	D-Grip	6 x 14	44
NN248	Straight	6 x 14	60

## SQUARE POINT SHOVELS

Model No.	Handle Type	Blade Size W" x H"	Overall Length"
NN245	D-Grip	8-1/2 x 11	40
NN246	Straight	8-1/2 x 11	59

## ROUND POINT SHOVELS

Model No.	Handle Type	Blade Size W" x H"	Overall Length"
NN243	D-Grip	8-1/2 x 11	40
NN244	Straight	8-1/2 x 11	59



- Heavy-duty, 12-gauge tempered carbon steel blade
- Durable fibreglass handle
- Ergonomic grip

## DRAIN SPADES

Model No.	Handle	Blade Size W" x H"	O.A. Length"
TLZ470	D-Grip	5-1/2 x 14	45
NN241	Straight	6 x 16	61

## SQUARE SHOVELS

Model No.	Handle	Blade Size W" x H"	O.A. Length"
TLZ468	D-Grip	9 x 11	41
TLZ469	Straight	9 x 11	56-1/2

## ROUND POINT SHOVELS

Model No.	Handle	Blade Size W" x H"	O.A. Length"
TLZ466	D-Grip	9 x 11	41
TLZ467	Straight	9 x 11	56-1/2

## BOW RAKE

Model No.	Number of Tines	Handle	Blade Size W" x H"	O.A. Length"
TLZ471	15	Straight	15 x 6	64

## GARDEN SPADE

Model No.	Handle	Blade Size W" x H"	O.A. Length"
NJ143	D-Grip	7-1/2 x 12	42



- Heavy-duty, 12-gauge tempered carbon steel blade
- Durable, ergonomic hardwood handle
- Forward-turned step for extra strength
- Ergonomic grip

## DRAIN SPADES

Model No.	Handle Type	Blade Size W" x H"	O.A. Length"
NN239	D-Grip	6 x 16	45
NN240	Straight	6 x 16	61

## SQUARE SHOVELS

Model No.	Handle Type	Blade Size W" x H"	O.A. Length"
NN237	D-Grip	9 x 11	41
NN238	Straight	9 x 11	59

## ROUND POINT SHOVELS

Model No.	Handle Type	Blade Size W" x H"	O.A. Length"
NN235	D-Grip	9 x 11	41
NN236	Straight	9 x 11	59

## BOW RAKE

Model No.	Number of Tines	Handle	Blade Size W" x H"	O.A. Length"
NN242	15	Straight	15 x 6	64



NN239

NN240

NN237

NN238

NN235

NN236

NN242

## SCOOP SHOVEL

- Perfect for moving and scooping lightweight granulated materials
- Lightweight construction for comfort and productivity
- Hardwood handle with aluminum blade resistant to rust
- Handle Type: Straight
- Weight: 4.16 lbs.



Model No.	Blade Size"	Overall Length"
TYX063	14 x 18	63-1/2

## BROADCAST SPREADERS

- Steel tube frame construction with chrome plated hardware
- Heavy-duty nylon gear box increases product life span
- Setting control on handle for precise adjustments
- Includes: Raincover, screen
- Pneumatic Tire Size: 12" x 4"

Model No.	Load Capacity	Coverage
NN137	50 lbs.	11 000 sq. ft.
NJ142	100 lbs.	22 000 sq. ft.



## BROADCAST SPREADERS WITH STAINLESS STEEL HARDWARE

- Metal gear inside of the gear box
- Stainless steel hardware in the hopper and pivot shaft
- Metal control handle
- Rate setting control on handle for precise adjustments
- Easy three-step assembly
- Includes: Raincover, screen

Model No.	Load Capacity	Pneumatic Tire Size	Coverage
NN138	70 lbs.	10"	15 000 sq. ft.
NN139	125 lbs.	14"	27 000 sq. ft.



## COLD WATER PISTOL GRIP NOZZLE

- Vinyl molded comfort grip
- For use with water temperatures under 26°C (80°F)
- Continuous-spray stainless steel clip
- Threaded for attaching accessories
- Non-Insulated
- Max. Pressure: 100 psi
- Rear-Trigger
- Body material: Zinc & Vinyl
- Fitting material: POM (Black Colour) with Aluminum Center (Brass Colour)

Model No. NM814



## COLD/WARM WATER PISTOL GRIP NOZZLE

- Heavy-duty construction and components
- For use with water temperatures up to 49°C (120°F)
- Continuous-spray stainless steel clip
- Threaded for attaching accessories
- Insulated
- Max. Pressure: 100 psi
- Rear-Trigger
- Body material: Zinc & TPR
- Fitting material: POM (Black Colour) with Aluminum Center (Brass Colour)

Model No. NM816



## COLD/WARM WATER PISTOL GRIP NOZZLE

- Ergonomic grip for longer usage
- For use with water temperatures up to 49°C (120°F)
- Continuous-spray stainless steel clip
- Screen filter prevents clogs
- Insulated
- Max. Pressure: 100 psi
- Rear-Trigger
- Body material: Zinc & ABS
- Fitting material: POM (Black Colour) with Aluminum Center (Brass Colour)
- Adjustment pin material: Aluminum

Model No. NM815



## HOT WATER PISTOL GRIP NOZZLE

- Heavy-duty construction and components
- Poly-clad metal body for use with hot and cold water
- For use with water temperatures up to 71°C (160°F)
- Continuous-spray stainless steel clip
- Threaded for attaching accessories
- Insulated
- Max. Pressure: 100 psi
- Rear-Trigger
- Body material: Zinc & TPR
- Fitting material: Aluminum (Brass Colour)
- Adjustment pin material: Aluminum & TPR

Model No. NM817



## HEAVY DUTY HOSE PISTOL

- Heavy-duty construction
- Threaded nozzle for attaching accessories
- Continuous-spray stainless steel clip
- Non-Insulated
- Max. Pressure: 60 PSI
- Trigger Type: Rear-Trigger

Model No. NO590



### GARDEN HOSES

- Hose made from virgin PVC, featuring good flexibility, abrasion, UV, oil and cracking resistance
- Stay flexible in temperatures: -10°C(14°F) to +65°C(150°F)
- Lightweight, kink resistant under pressure
- Abrasion resistant outer cover
- UV, Ozone, cracking, chemicals, and oil resistant
- 300 psi maximum working pressure
- Hose Diameter: 5/8"
- Couplings: Brass



NO965



### HYBRID HOSES

- All weather flexibility even in sub-zero conditions: -25°C(-13°F) to +70°C(158°F)
- Lightweight, lay flat and no memory, kink resistant under pressure
- Abrasion resistant outer cover
- UV, Ozone, cracking, chemicals, and oil resistant
- Bend restrictor for reducing wear and tear, and extending hose life
- Easy coiling after use
- Hose Diameter: 5/8"
- Hose Material: Copolymer



NO963



Model No.	Hose Length <sup>1</sup>
NO963	50
NO964	100

### CONTRACTOR-DUTY HOSES

- All weather flexibility even in sub-zero conditions: -30°C(-22°F) to +82°C(180°F)
- Kink resistant under pressure
- Excellent abrasion resistant outer cover
- 400 psi maximum pressure
- Easy coiling after use
- Hose Diameter: 5/8"
- Hose Material: Rubber
- Couplings: Brass

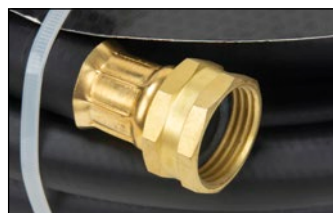

NO486



Model No.	Hose Length <sup>1</sup>
NO486	25
NO487	50
NO488	100



## STANDARD BLUE TARPS

- Reinforced polypropylene rope sewn in welded hems
- Heavy-duty rust-resistant grommets every 3'
- Increased UV resistance for long life
- Water-resistant coating
- Finished sizes may vary due to hem allowance
- 8 x 8 weave density
- 100 micrometres (4-mil) thick

**KLETON**



NN363

Model No.	W'	L'
NN363	7	5
NN364	8	6
NN365	10	8
NN366	12	10
NN377	14	10
NN378	16	10
NN367	20	10
NN379	14	12
NN368	16	12
NN380	18	12
NN381	20	12

Model No.	W'	L'
NN382	24	12
NN369	20	16
NN383	20	18
NN370	24	18
NN384	24	20
NN371	30	20
NN372	30	24
NN373	40	30
NN374	50	30
NN375	50	40
NN376	60	40

## WHITE TARPS

- Reinforced polypropylene rope sewn in welded hems
- Heavy-duty rust-resistant grommets every 3'
- Increased UV resistance for long life
- Water-resistant coating
- Finished sizes may vary due to hem allowance
- 10 x 10 weave density
- 150 micrometres (6-mil) thick
- Four corner patches
- Type: Heavy-Duty

**KLETON**



NN385

Model No.	W'	L'
NN385	8	6
NN386	10	8
NN387	12	10
NN388	16	12
NN389	20	16
NN390	24	18

Model No.	W'	L'
NN391	30	20
NN392	30	24
NN393	40	30
NN394	50	30
NN395	50	40
NN396	60	40

## GREEN SILVER REVERSE TARPS

- Reinforced polypropylene rope sewn in welded hems
- Heavy-duty rust-resistant grommets every 3'
- Increased UV resistance for long life
- Water-resistant coating
- Finished sizes may vary due to hem allowance
- 14 x 14 high density weave
- 225 micrometres (9-mil) thick
- 9" x 9" three layers on each four corners
- Type: Heavy-Duty

NN397

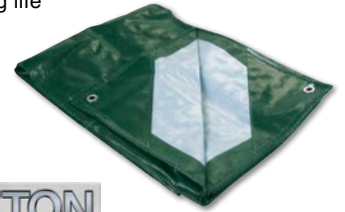

**KLETON**

Model No.	W'	L'
NN397	8	6
NN398	10	8
NN399	12	10
NN400	16	12
NN401	20	16

Model No.	W'	L'
NN402	30	20
NN403	40	30
NN404	50	30
NN405	50	40
NN406	60	40

## SILVER TARPS

- Reinforced polypropylene rope sewn in welded hems
- Heavy-duty rust-resistant grommets every 3'
- Increased UV resistance for long life
- Water-resistant coating
- Finished sizes may vary due to hem allowance
- 16 x 16 high density weave
- 300 micrometres (12-mil) thick
- 9" x 9" triple-layered on four corners
- Type: Super Heavy-Duty

NN407



**KLETON**

Model No.	W'	L'
NN407	10	8
NN408	12	10
NN409	20	16
NN410	24	18
NN411	30	20

Model No.	W'	L'
NN412	30	24
NN413	40	30
NN414	50	30
NN415	60	30
NN416*	40	60

\*Water Resistant

## CLEAR TARPAULIN

- Polyethylene tarpaulin with reinforced nylon gridding
- Water and mildew resistant coating
- Heavy-duty rust resistant grommets
- 3 x 3 weave density
- 200 micrometers (8-mil) thick
- Finished sizes may vary due to hem allowance

NN417



**KLETON**

Model No.	W'	L'
NN417	10	8
NN418	12	10
NN419	20	16

Model No.	W'	L'
NN420	30	20
NN421	40	30
NN422	60	40

# WINTER ACCESSORIES

Snow Pushers .....	97
Snow Shovels .....	97
Snow Brushes.....	97
Snow Roof Rake .....	98
Booster Cables .....	98



## ▶ POLY SNOW PUSHERS

- Powder-coated steel handle for added strength
- Ergonomic poly D-grip
- **NM812**: includes a steel wearstrip



Model No.	Blade Size"	Overall Length"
<b>NM811</b>	24-1/2 x 10-3/4	54-1/2
<b>NM812</b>	21-1/4 x 9-1/4	50-1/2

## ▶ POLY SNOW SHOVELS

- Powder-coated steel handle for added strength
- Ergonomic poly D-grip handle
- **NM809** includes a steel wearstrip



Model No.	Blade Size"	Overall Length"
<b>NM809</b>	19-3/4 x 13-1/8	50-3/4
<b>NM810</b>	19-3/4 x 13	51-3/8

## ▶ LONG REACH SNOW BRUSH

- Aluminum handle with comfortable EVA foam grip
- Overall Length: 34"
- Non Telescopic
- Colour: Blue
- Blade Type: Polypropylene
- Head Width: 8-3/4"
- Handle Material: Aluminum/Foam
- Scraper Width: 5"

Model No. **NM979**



## ▶ TELESCOPIC SNOW BRUSH

- Aluminum handle with comfortable EVA foam grip
- Telescopic handle has extended length of 36" and collapsed length of 26"
- Colour: Blue
- Blade Type: Polypropylene
- Head Width: 9-3/4"
- Handle Material: Aluminum/Foam
- Scraper Width: 5"

Model No. **NM980**



## ▶ FOAM & BRISTLE SNOW BRUSH

- Soft EVA foam to prevent scratches
- Extends from 33" to 48"
- Rotating head with plastic bristles
- Overall Length: 48"
- Telescopic
- Colour: Black, Blue
- Blade Type: EVA Foam
- Head Width: 12-3/4"
- Handle Material: Plastic

Model No. **NN434**



## SNOW ROOF RAKE

- Ideal for removing any kind of debris from roofs
- Prevents roof damage by removing ice dams & heavy snow
- Shipped knocked down
- Lightweight handle extends to 16'
- Blade Material: Polypropylene
- Blade Width: 24-3/4"
- Blade Height: 6"
- Handle Length: 61"
- Handle Material: Aluminum
- Handle Type: Straight
- Weight: 4 lbs.

Model No. NN009



## BOOSTER CABLES

- Clamp design fits on both top-post and side-post batteries
- Surge suppressor on 2, 4, and 6 gauge cables protect a vehicles computer system from power surges during boosting
- Cable remains flexible in temperatures as low as -40°C
- Tangle-free

Model No.	Wire Gauge	Amps	Length'
XE494	8	150	10
XE495	6	400	16
XE496	4	400	20
XE497	2	40	20

XE494

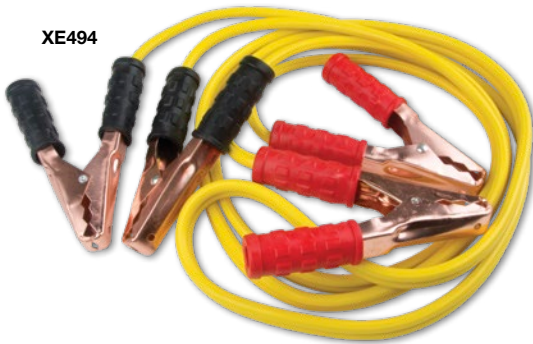

XE495



XE496



XE497



# ELECTRICAL

Extension Cords .....	100, 101, 102
Workshop Power Box .....	102
Surge Suppressor .....	103
Ground Connectors.....	103
Batteries .....	104
Analog Battery Tester .....	104

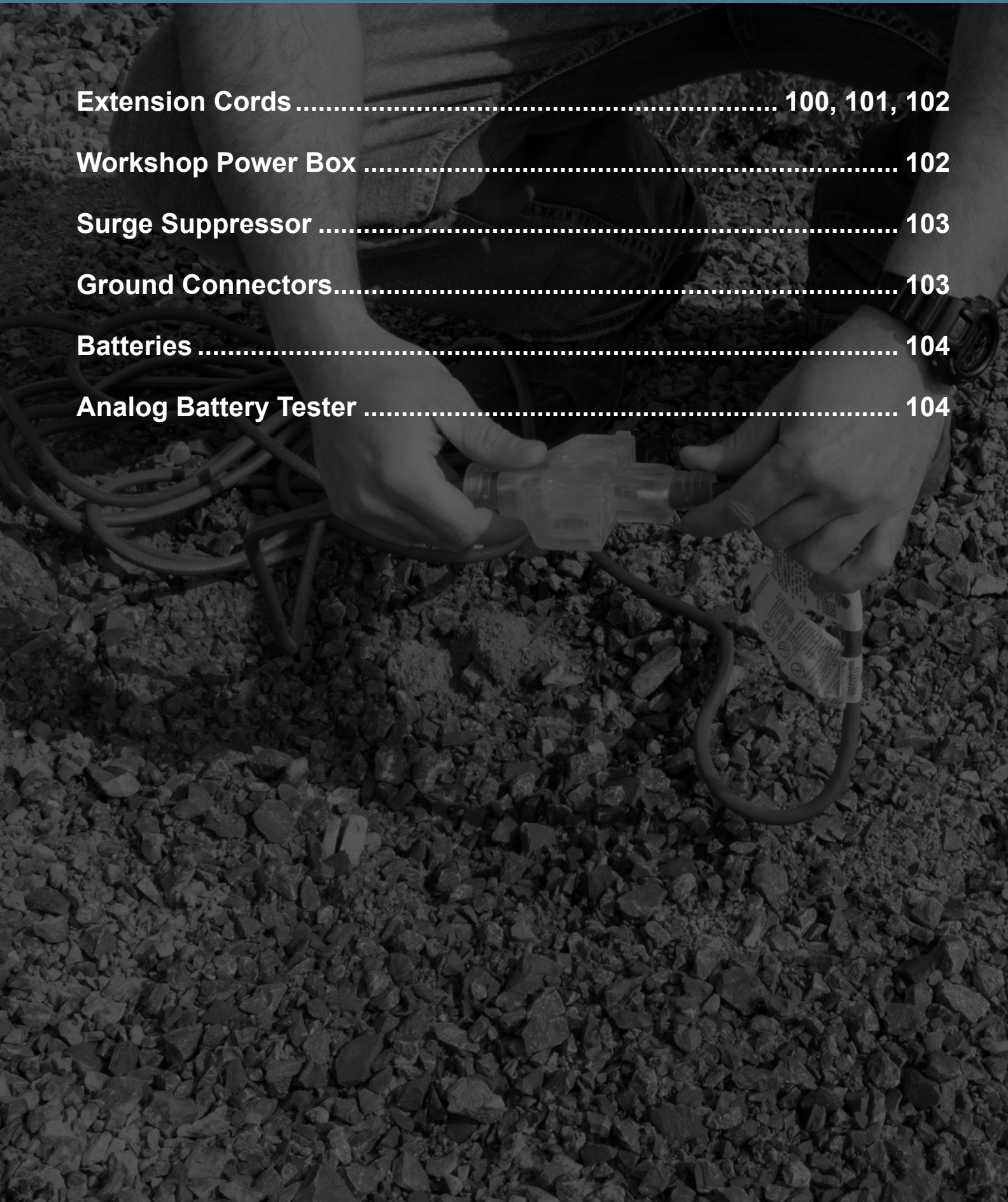

## ▶ OUTDOOR VINYL EXTENSION CORDS

- Designed for industrial and contractor use
- Vinyl jacket protects against rough use, chemicals, and moisture and provides added flexibility
- Molded-on and bonded plugs and connectors resist breaking

### 3-CONDUCTOR SJTW, 300 VOLTS GROUNDING

Model No.	Length'	AWG	Amps	Watts	Colour
<b>HEAVY-DUTY</b>					
XC482	25	14/3	15	1875	Orange
XC483	50	14/3	15	1875	Orange
XC484	100	14/3	13	1625	Orange
<b>EXTRA HEAVY-DUTY</b>					
XC485	25	12/3	15	1875	Yellow
XC486	50	12/3	15	1875	Yellow
XC487	100	12/3	15	1875	Yellow

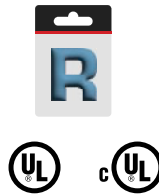

XC482



XC485



## ▶ OUTDOOR VINYL EXTENSION CORDS WITH LIGHT INDICATOR

- Designed for industrial and contractor use
- Vinyl jacket protects against rough use, chemicals, and moisture
- Ultra flexible cord
- Lighted connectors allow you to see when the power is in use
- Molded-on and bonded plugs and connectors resist breaking
- Water resistant and flame retardant

### 3-CONDUCTOR SJTOW, 300 VOLTS GROUNDING, OIL RESISTANT

Model No.	Length'	AWG	Amps	Watts	Colour
<b>EXTRA HEAVY-DUTY</b>					
XC494	25	12/3	15	1875	Yellow
XC495	50	12/3	15	1875	Yellow
XC496	100	12/3	15	1875	Yellow



## ▶ OUTDOOR TRIPLE TAP VINYL EXTENSION CORDS WITH LIGHT INDICATOR

- Same great features as outdoor single tap vinyl extension cords but with a lighted triple tap connector

### 3-CONDUCTOR SJTOW, 300 VOLTS GROUNDING, OIL RESISTANT

Model No.	Length'	AWG	Amps	Watts	Colour
<b>EXTRA HEAVY-DUTY</b>					
XC497	25	12/3	15	1875	Yellow
XC498	50	12/3	15	1875	Yellow
XC499	100	12/3	15	1875	Yellow



## ▶ OUTDOOR VINYL TRIPLE TAP EXTENSION CORDS

- Designed for industrial and contractor use
- Vinyl jacket protects against rough use, chemicals, and moisture
- Vinyl jacket provides added flexibility
- Molded-on and bonded plugs and connectors resist breaking

### 3-CONDUCTOR SJTW, 300 VOLTS GROUNDING

Model No.	Length'	AWG	Amps	Watts	Colour
<b>HEAVY-DUTY</b>					
XC488	25	14/3	15	1875	Red
XC489	50	14/3	15	1875	Red
XC490	100	14/3	13	1625	Red
<b>EXTRA HEAVY-DUTY</b>					
XC491	25	12/3	15	1875	Red
XC492	50	12/3	15	1875	Red
XC493	100	12/3	15	1875	Red



## ▶ INDOOR/OUTDOOR STANDARD-DUTY EXTENSION CORDS

- Designed for light industrial, contractor, and home use
- Durable SJTW jacket protects against ultraviolet rays, chemicals and moisture
- Extremely flexible jacket
- Molded-on and bonded plugs and connectors resist breaking

### 3-CONDUCTOR SJTW, 125 VOLTS GROUNDING

Model No.	Length'	AWG	Amps	Watts	Colour
XC630	10	16/3	13	1625	Orange
XC631	15	16/3	13	1625	Orange
XC632	25	16/3	13	1625	Orange
XC633	50	16/3	13	1625	Orange



## ▶ ALL WEATHER TPE-RUBBER EXTENSION CORDS WITH LIGHT INDICATOR

- Designed for industrial and contractor use
- All weather jacket provides ultra flexibility and superior performance in extreme climate conditions at temperatures from -50°C to 105°C
- Provides outstanding resistance against rough use, sunlight, chemicals and moisture
- Water resistant and flame retardant
- Lighted connectors allow you to see when the power is in use
- Molded-on and bonded plugs and connectors resist breaking

### 3-CONDUCTOR SJEOW, 300 VOLTS GROUNDING

Model No.	Length'	AWG	Amps	Watts	Colour
<b>HEAVY-DUTY</b>					
XC500	25	14/3	15	1875	Blue/Orange
XC501	50	14/3	15	1875	Blue/Orange
XC502	100	14/3	13	1625	Blue/Orange
<b>EXTRA HEAVY-DUTY</b>					
XC503	25	12/3	15	1875	Blue/Orange
XC504	50	12/3	15	1875	Blue/Orange
XC505	100	12/3	15	1875	Blue/Orange



## TRIPLE TAP ALL-WEATHER TPE-RUBBER EXTENSION CORDS WITH LIGHT INDICATOR

- Designed for industrial and contractor use
- All-weather jacket provides ultra flexibility and superior performance in extreme climate conditions at temperatures from -50°C to 105°C
- Provides outstanding resistance against rough use, sunlight, chemicals and moisture
- Water-resistant and flame retardant
- Lighted connectors allow you to see when the power is in use
- Molded-on and bonded plugs and connectors resist breaking



### 3-CONDUCTOR SJEOW, 300 V GROUNDING

Model No.	Length'	AWG	Amps	Watts	Colour
<b>HEAVY-DUTY</b>					
XH235	25	14/3	15	1875	Blue/Orange
XH236	50	14/3	15	1875	Blue/Orange
XH237	100	14/3	13	1625	Blue/Orange
<b>EXTRA HEAVY-DUTY</b>					
XH238	25	12/3	15	1875	Blue/Orange
XH239	50	12/3	15	1875	Blue/Orange
XH240	100	12/3	15	1875	Blue/Orange

## WIND-UP EXTENSION CORD

- 4 grounded outlets
- Built-in resettable circuit breaker
- Wind-up the cord by manually rotating the wheel
- Length: 25'
- Gauge (AWG): 16/3
- Amps: 10 A
- Wattage: 1250 W

Model No. XE671



## WORKSHOP POWER BOX

- Features cord wrap and surge protector to protect your devices from an overload
- Lighted on/off switch
- Keyhole slots on the back of the unit allow the model to be mounted under a desk, on walls or other locations
- Indoor use only
- Outlets: Total of 8 - 5 standard, 3 wide space
- Housing Material: Metal
- Cord Length: 6'
- Amps: 15 A
- Wattage: 1875 W
- Voltage: 125 V
- Rated Joules: 1350 J

Model No. XH162





## ▶ SURGE SUPPRESSOR

- Lighted on/off switch with built-in circuit breaker
- Protects against damage caused by power spikes
- Ideal for multiple electronic devices
- No. of Outlets: 6
- Cord Length: 3'
- Amps: 15 A
- Wattage: 1875 W
- Voltage: 125 V
- Rated Joules: 200



Model No. XE670



## ▶ USB CHARGING SURGE PROTECTOR

- USB Power Strip will protect devices from power surges and spikes
- Protected mode indicator light
- Lighted ON/OFF switch
- No. of Outlets: 6
- Cord Length: 6'
- Amps: 15 A
- Wattage: 1875 W
- Voltage: 125 V
- No. of USB Ports: 2
- USB Charging Ports: 2.1 Amp
- Housing Material: ABS Plastic
- Colour: White
- Rated Joules: 1200 J



Model No. XH064



## ▶ PVC GROUNDING CONNECTOR

- Moisture and chemical resistant plastic body
- Ideal for indoor and outdoor use
- Amps: 15 A
- Volts: 125 V
- Cord diameter: 0.245" - 0.655"
- Wire gauge: 16/3 to 14/3 cords
- Colour: Yellow
- Nema configuration: 5-15P/5-15R
- Body material: Plastic

Model No. XE673



## ▶ PVC GROUNDING PLUG

- Moisture and chemical resistant plastic body
- Ideal for indoor and outdoor use
- Amps: 15 A
- Volts: 125 V
- Cord diameter: 0.245" - 0.655"
- Wire gauge: 16/3 to 14/3 cords
- Colour: Yellow
- Nema configuration: 5-15P/5-15R
- Body material: Plastic

Model No. XE672



# ALKALINE BATTERIES

- Mercury-free
- Cadmium-free
- Aluminium jacket
- 7 Year shelf life
- Voltage: 1.5 V

XI880



XI879



Model No.	Battery Type
XI879	AA
XI880	AAA



## ▶ ANALOG BATTERY TESTER

- Compatible with the majority of standard household batteries
- Analog scale displays the capacity of the battery instantly (Replace, Low, Good)
- No batteries required to operate
- Movable arm can fit multiple battery sizes
- Compact size and easy to use
- Battery Type(s): AAA, AA, C, D, 9V



Model No. XF613



# LIGHTING

Worklights .....	106, 107
Flashlights.....	108
Headlamps .....	109



## PORTABLE HALOGEN WORK LIGHT

- Heat resistant tempered glass face with steel housing
- Adjustable tilting head
- IP54 rating for weather and dust resistance
- Certified for sale in Canada by an accredited certification body
- Wattage: 500W
- Lumens: 8000

Model No. XC949

### REPLACEMENT BULB

Model No. XC951



## PORTABLE LED WORK LIGHT

- Adjustable tilting head
- Housing Material: Aluminum
- Certified for sale in Canada by an accredited certification body
- IP65 rating for weather and dust resistance
- Wattage: 20
- Lumens: 2500

Model No. XG816



## TWIN-HEAD HALOGEN WORK LIGHT

- Twin 500-watt halogen lights
- Heat resistant tempered glass face in steel housing
- Adjustable tripod for desired height
- Extendable tripod legs provide greater stability
- Colour: Black and yellow
- Certified for sale in Canada by an accredited certification body
- IP54 rating for weather and dust resistance
- Lumens: 16000

Model No. XC950

### REPLACEMENT BULB

Model No. XC951



## TWIN-HEAD LED WORK LIGHT

- Adjustable tripod for desired height
- Extendable tripod legs provide greater stability
- Fixtures can adjust 120°
- Certified for sale in Canada by an accredited certification body
- Housing Material: Aluminum
- IP65 rating for weather and dust resistance
- Wattage: 40
- Lumens: 4800

Model No. XG817



## DOCK LIGHT

- Built-in on-off switch
- Durable stainless steel cage for better protection of the light
- Bracket mounted for easy installation
- Arm sections are adjustable in all directions
- Features an adjustable screw to help direct the light where you need it
- Ideal for use in shipping/receiving docks, work lighting, spot lighting, and other similar applications
- Extended Arm Length: 40"
- Lamp Type: LED
- Wattage: 50W
- Head Type: Metal
- Lumens: 5500

Model No. XI316



## LED STRING WORK LIGHTS

- Each panel light outputs up to 1000 lumens
- LED bulbs built-in, no replacement bulbs required
- The integrated LED lights are designed to last for 30000 hours
- Low power consumption allows 12 additional sets to be linked together
- Ideal for construction sites, indoor & outdoor use
- Comes with optional carabiners
- Cord Length: 50'
- Housing Material: Plastic
- Wire Gauge: 16/2
- Number of Lights: 5
- Light Temperature: 5000K
- Environmental Rating: IP55
- Wattage Per Panel: 10W
- Lumens Per Panel: 1000
- Distance Between Panels: 8-5/6'



Model No. XI021

## INDUSTRIAL WORK LIGHT

- Light Capacity (watts): 75
- Cord Length: 25'
- Rugged impact resistant housing
- On/Off switch handle
- Certified for sale in Canada by an accredited certification body
- Lightweight design
- Grounded cord
- Includes: Hanging hook and electric outlet

Model No. XC660



## AFL100 LED FLASHLIGHT

- Super bright LED bulb
- Polypropylene body resists grease and chemicals
- Shatterproof lens
- Ribbed non-slip barrel
- High visibility yellow colour for easy visibility
- Batteries not included



Model No.	Description	Lumens
XC977	Flashlight, 2 AA-cells	28
XC978	Flashlight, 2 D-cells	35

## AFL400 RECHARGEABLE LED SPOTLIGHT

- Single LED spotlight has an extremely bright beam featuring long distance visibility
- Spotlight features an additional side-light that can be used as a free-standing lantern
- Certified for sale in Canada by an accredited certification body
- Spotlight is ideal for various applications, such as household work, facility maintenance, general labor and recreational activities
- Side-light Lumens: 180
- Lumens (High): 516
- Run Time Hrs. (High): 6
- Material: Plastic
- Beam Distance (High): 500 m
- Batteries Included



Model No. XH109

## AFL300 LED FLASHLIGHTS

- Material: Aluminum
- Colour: Black
- High strength aluminum casing
- Shatterproof lens
- Batteries included
- **XJ059**: 3 lighting settings: Low 9 LED, Medium 24 LED and High 45 LED



XE888



XJ059

Model No.	Lumens (High)	Run Time Hrs (High)	Batteries Required	Beam Distance	Bulb
XE888	98	3	3 AAA	35 m	28 LED
XJ059	180	10	3 AA	48 m	45 LED

## AFL200 MINI LED FLASHLIGHT

- Includes wrist strap and three AAA alkaline batteries
- Nine ultra bright LED lights
- 25 lumens
- High-strength aluminum casing
- On/Off switch
- Lightweight design
- Rugged impact resistant housing



Model No. XD079

## CREE® LED PENLIGHT

- Penlight is extremely durable while lightweight to alleviate wrist fatigue
- Aluminum body is corrosion and rust-resistant
- Attaches securely to pockets, belts and briefcases with convenient clip
- Penlight is ideal for various applications such as household work, automobile maintenance and recreational activities
- Run Time Hrs. (High): 3
- Beam Distance (High): 70 m
- Batteries included: 2 x AAA
- Lumens: 90



Model No. XJ058

## LED HEADLAMP

- 7 ultra bright LED lights
- 3 brightness levels: 7 LEDs, 3 LEDs, 1 LED
- Water resistant
- Lightweight design
- Tilting head and adjustable head strap
- Batteries Required: 3 AAA
- Lumens (High): 28
- Runtime (High): 20 hours
- Beam Distance: 10m

Model No. XC658



Hard hat  
not included

## CREE® LED HEADLAMP

- 3 settings: High, Low and Strobe
- Head angle is adjustable
- Adjustable in/out zoom
- Water resistant
- Batteries Required: 3 AAA
- Lumens (high): 120
- Lumens (low): 30
- Run time (high): 6 hours
- Run time (low): 20 hours
- Beam Distance (high): 120m

Model No. XE887



## RECHARGEABLE HEADLAMP

- Emits a light of 350 lumens on high for up to 2 hours, and 15 hours when set to low at 40 lumens
- IPX7 Waterproof rating (1m, 30min)
- Battery charge light indicator on the side
- 2m impact resistance
- Adjustable headband
- Includes: Headlamp, Micro-USB recharging cable, Helmet clips
- Lamp Type: LED
- Run Time Hrs. (High): 15
- Battery Type: Rechargeable
- Beam Distance (High): 110 m
- Light Colour: White
- Lumens (High): 350
- Lamp Material: Rubber
- Body Colour: Black
- Batteries Included

Model No. XI801



# PACKING & SHIPPING

Staple Guns.....	111
Hammer Tackers.....	111
Glue Guns .....	111
Utility Knives.....	112, 113
Utility Blades.....	113
Cable Ties.....	113
Stretch Wrap Dispenser.....	114
Bag Sealer.....	114
Rubber Tie Downs .....	114
Tape Dispensers .....	115
Box Tape.....	115
Duct Tape .....	116
Manual Gummed Tape Dispenser .....	116
Impulse Sealers .....	116



## HEAVY-DUTY STAPLE GUN

- All-steel construction, with rubberized handle for superior grip
- Easy squeeze, double leverage handle reduces operators fatigue
- Hand-contoured handle features molded plastic handle stop
- Bottom loading, with jam proof mechanism
- Adjustable driving force facilitates use
- Accepts staples in 3 lengths: 5/16", 3/8" and 1/2", with a crown width of 3/8"

Model No. PE337



## HEAVY-DUTY HAMMER TACKER

- All-steel construction, with rubberized handle for superior grip
- Precision locked rear loading, with jam proof mechanism
- Retractable striking edge
- Chrome plated finish
- Accepts staples in 5 lengths: 1/4", 5/16", 3/8", 1/2" and 9/16", with a crown width of 3/8"

Model No. PG362



## STAPLES

- Finish: Plain

Model No.	Length	Crown"	Gauge	Qty /Box
ON919	5/16" (8 mm)	3/8	0.3125	500
ON920	3/8" (10 mm)	3/8	9	500
ON921	1/2" (13 mm)	3/8	16	500



## GLUE GUNS

- Accepts 7/16" diameter regular glue sticks
- Trigger design for better grip control
- Features precise, even adhesive distribution
- Comes with metal wire stand
- Operating Temperature: 245°F - 380°F (120°C - 193°C)
- PE340: Illuminated on/off switch



Model No.	Description	Heater
PE339	Light-Duty	120 Volt (80 Watt)
PE340	Heavy-Duty	120 Volt (100 Watt)

## GLUE STICKS

Model No.	Appearance	Viscosity	Melting Point		Typical Applications	Dim."	Qty /Case
			°C	°F			
PE341	Clear	11 000-13 000	77-82	170-180	High Strength, High Temp, For Non Porous Materials	7/16 x 4	2000
PE342	Clear	11 000-13 000	77-82	170-180	High Strength, High Temp, For Non Porous Materials	7/16 x 10	803
PE343	Amber	5000	95	203	All Temp, For Porous Materials	7/16 x 15	536
PE541	Clear	9400	80	176	All temp, For Porous & Non Porous Materials	7/16 x 10	803

\*Sold/Priced Per Stick

## HEAVY-DUTY UTILITY KNIFE ATK100

- Auto-reload blade change
- Auto-lock blade
- Rubber handle insert for superior grip
- Snap-off blades
- Attached blade snapper
- Includes 4 heavy-duty carbon steel blades
- Uses 18 mm blade



Model No. PE812

## PROFESSIONAL UTILITY KNIFE ATK300

- Auto-lock blade
- Snap-off blades
- Attached blade snapper
- Uses 18 mm blade



Model No. PE814

## PROFESSIONAL UTILITY KNIFE ATK400

- Blade screw lock
- Snap-off blades
- Comes with blade snapper
- Uses 18 mm blade



Model No. PE813

## STAINLESS STEEL UTILITY KNIFE ATK500

- Auto-lock blade
- Snap-off blades
- Attached blade snapper
- Built-in belt clip
- Uses 9 mm blade



Model No. PE815

## STANDARD-DUTY UTILITY KNIFE ATK600

- Snap-off blades
- Attached blade snapper
- Uses 9 mm blade



Model No. PE345

## STANDARD-DUTY UTILITY KNIFE ATK700

- Auto-lock blade
- Durable ABS plastic body
- Snap-off blades
- Attached blade snapper
- Lightweight design
- Uses 18 mm blade



Model No. PE549

## HEAVY-DUTY UTILITY KNIFE ATK800

- Blade screw lock
- Snap-off blades
- Ergonomic handle for superior grip
- Uses 25 mm blade

Model No. PF710



## HEAVY-DUTY UTILITY KNIFE ATK900

- Ergonomic handle for superior grip
- Snap-off blades
- Blade Size: 18 mm
- Blade Material: Carbon Steel
- Blade Length: 139 mm
- Blade Thickness: 0.5 mm
- Locking Mechanism: Screw

Model No. PF711



## SELF-RETRACTING UTILITY KNIFE ATK1000

- Self-retracting blade for heightened safety
- Durable ABS plastic body
- Lightweight design
- Durability: Utility
- Blade Size: 18 mm
- Blade Material: Carbon Steel
- Blade Thickness: 0.5 mm

Model No. PF708

**REPLACEMENT  
BLADES:**  
Model No. PF709



## REPLACEMENT UTILITY KNIFE BLADES

Model No.	Blade Size	Thickness	Qty/Pack
PE407	9 mm	0.4 mm	10
PF205	18 mm	0.5 mm	10
PE410	25 mm	0.7 mm	10



## CABLE TIES

- Manufactured from Dupont™ Zytel® 101F and Ascend™ Vydyn® 21SPF
- Ideal use in temperatures ranging from -20° C to 80°C
- PF396 has the added benefit of weather resistance

Model No.	Style	Length"	Bundle Dia. Min." - Max."	Tensile Strength lbs.	Qty /Bag
PF385	Natural	4	1/16 - 7/8	18	1000
PF386	Black	4	1/16 - 7/8	18	1000
PF387	Natural	6	1/16 - 1-1/4	40	1000
PF388	Black	6	1/16 - 1-1/4	40	1000
PF389	Natural	8	1/16 - 1-3/4	50	1000
PF390	Black	8	1/16 - 1-3/4	50	1000
PF391	Natural	11	1/16 - 3	50	1000
PF392	Black	11	1/16 - 3	50	1000
PF393	Natural	15-1/2	1/16 - 4	120	100
PF394	Black	15-1/2	1/16 - 4	120	100
PF395	Natural	24	3/16 - 7	175	100
PF396	Black	24	1/16 - 7	175	100



## CABLE TIE SETS

Same great features as the Aurora cable ties, but with the added convenience of a set with mixed sizes.

**Model No. PF397  
SET INCLUDES:**  
400 x PF387  
400 x PF389  
200 x PF391

**Model No. PF398  
SET INCLUDES:**  
50 x PF393  
50 x PF395

## STRETCH WRAP DISPENSER

- For a smooth, tight application of stretch wrap
- Needle bearings at the top and bottom of the unit increase tension control
- Tension control knob on top ensures a tight, smooth wrap
- Tension knob also provides a second hand grip for added stability
- Adjusts to hold rolls from 11" to 18" wide

Model No. PE354



KLETON

## BAG SEALER

- Heavy-duty bag sealer with tape cutter
- Easy to use: just twist bag shut and move through slot

Model No. PE356

### REPLACEMENT BLADES:

Model No. PE383



KLETON

## RUBBER TIE DOWNS

- Material: EPDM gives the ability to resist degradation resulting from weathering agents like UV rays and ozone making it perfect weather resistant rubber
- Retains its rebound qualities
- Rubber Tie Downs Straps resist cracking and rotting
- Durable Zinc plated steel "S" hooks

Model No.	Length"	Max. Safe Stretch"
PE366	5	7.5
PE367	9	13.5
PE368	15	22.5
PE369	21	31.5
PE370	31	46.5
PE371	41	61.5



## RUBBER TIE DOWN SETS

- Same great features as KLETON rubber tie downs however in the convenience of sets

### 10-PC. TIE DOWN SET

#### SET INCLUDES:

- 4 - 21" Tie Downs (PE369)
- 2 - 31" Tie Downs (PE370)
- 4 - 41" Tie Downs (PE371)

Model No. PF090

KLETON

### 16-PC. TIE DOWN SET

#### SET INCLUDES:

- 2 - 9" Tie Downs (PE367)
- 2 - 15" Tie Downs (PE368)
- 4 - 21" Tie Downs (PE369)
- 4 - 31" Tie Downs (PE370)
- 4 - 41" Tie Downs (PE371)

Model No. PF091

### 20-PC. TIE DOWN SET

#### SET INCLUDES:

- 10 - 21" Tie Downs (PE369)
- 10 - 41" Tie Downs (PE371)

Model No. PF092

## ▶ TAPE DISPENSERS

- Industrial quality tape guns constructed of steel and high impact plastic frame
- Adjustable brake lets you choose the desired release tension

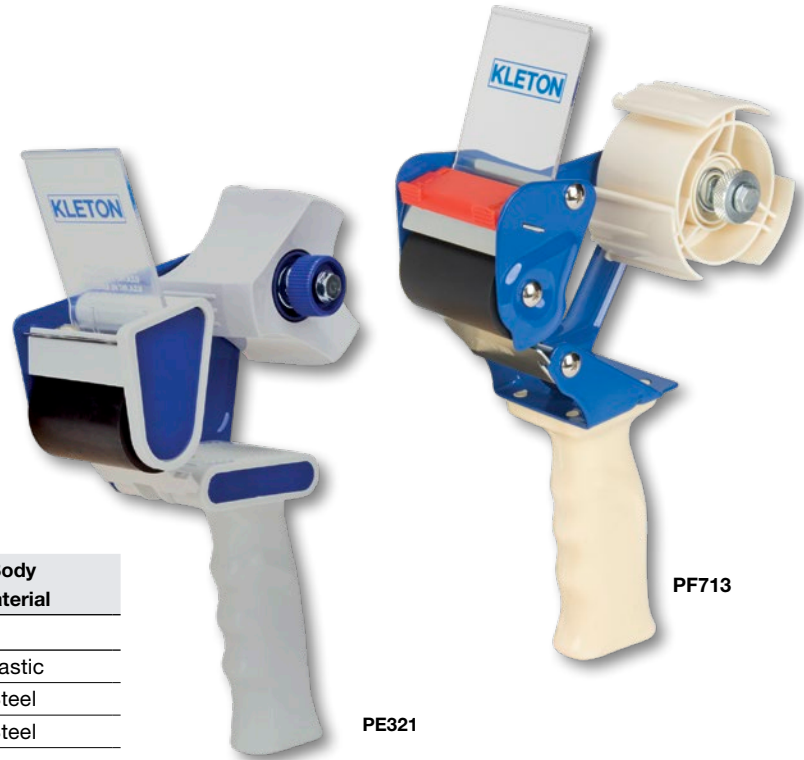

# KLETON

Model No.	Max. Tape Width"	Type	Body Material
<b>RETRACTABLE</b>			
PE321	2	Standard-Duty	Plastic
PE322	2	Heavy-Duty	Steel
PE323	3	Heavy-Duty	Steel
<b>NON-RETRACTABLE</b>			
PF712	2	Standard-Duty	Plastic
PF713	2	Heavy-Duty	Steel
PF714	3	Heavy-Duty	Steel

## ▶ ACRYLIC BOX TAPES

- Quality acrylic adhesive tape provides consistent performance
- Ideal for long term storage and lightweight carton sealing
- Works well in extreme temperatures
- Will not yellow with age



PF231

# KLETON

Model No.	Dimensions	Thickness	
		Microns	Mils
PF231	2" x 216' (48 mm x 66 m)	40	1.6
PF232	2" x 328' (48 mm x 100 m)	40	1.6
PF233	2" x 328' (48 mm x 100 m)	50	2.0
PF234	3" x 216' (72 mm x 66 m)	40	1.6
PF235	2" x 432' (48 mm x 132 m)	40	1.6

## ▶ HOT MELT BOX TAPES

- Possesses superior holding power and tensile strength
- Ideal for use with boxes containing high amounts of recycled content
- Suitable for shipping and short-term storage



PG127

# KLETON

Model No.	Dimensions	Thickness	
		Microns	Mils
PG127	2" x 216' (48 mm x 66 m)	40	1.6
PG128	2" x 328' (48 mm x 100 m)	40	1.6
PG129	2" x 328' (48 mm x 100 m)	50	2.0
PG130	3" x 216' (72 mm x 66 m)	40	1.6
PG131	2" x 432' (48 mm x 132 m)	40	1.6

## UTILITY GRADE DUCT TAPES

- Ideal for a wide variety of projects and applications
- Water resistant
- Easy to tear
- Colour: Silver



# KLETON



Model No.	Width	Length	Thickness
PF688	50 mm (2")	55 m (180')	9 mils
PF689	50 mm (2")	45 m (148')	6 mils

## MANUAL GUMMED TAPE DISPENSER

- A single pull of the handle moistens and dispenses the required length of gummed tape.
- Manual lever dispenses and cuts tape up to 44" long
- Fits Tape Width Up To: 100 mm ( 4")
- Weight: 20.46 lbs.

Model No. PG200

# KLETON



## REINFORCED KRAFT TAPE

- Water activated adhesive bonds to the carton even in dusty or dirty conditions
- Reinforced with fiberglass, adding strength to the tape
- Works well with recycled cardboard
- Recommended for use on lightweight cartons of up to 20 lbs
- Width: 3"
- Length: 150 m (492')
- Colour: Kraft

Model No. PG132

# KLETON

## HEAT IMPULSE SEALERS

- Used for sealing polyethylene, polypropylene, and PVC bags
- Compact design
- Lightweight
- Easy to operate
- 110 V

Model No.	Size"	Power
PF464	8	260 W
PF465	12	380 W

Replacement Silicon strip	Replacement PTFE Strip
PF467	PF468
PF470	PF471

# KLETON



# WELD-ON STEEL HINGES

- Ideal for gates, machinery doors, BBQ pits, electrical boxes, trailers and more
- Can be painted to match the door and frame
- Hinges are specially buffed and are free of burrs allowing for improved paint adherence
- Comes standard with rounded ends and with/without grease fittings
- Installation: Ensure the hinge is welded along the full length of the weld tab
- Component replacement parts are available
- Built to print solutions are available upon request
- Frame Material: Mild Steel with Fixed Steel Pin
- Bushing Material: Brass

TTV433



TTV437

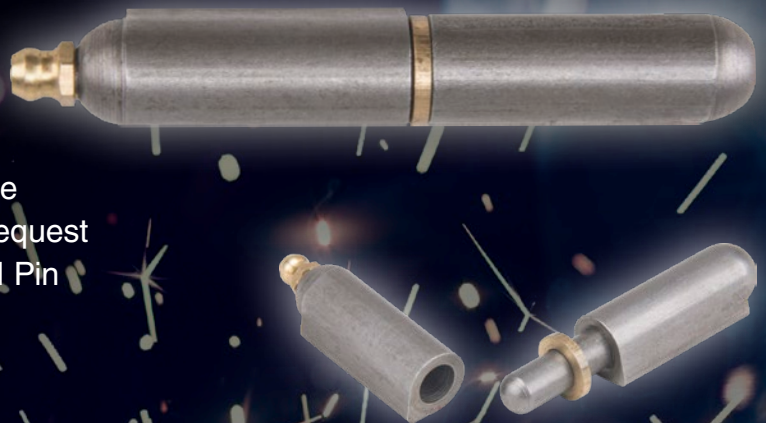

Model No.	Grease Fitting	Length"	Diameter"	Pin Diameter"	Thickness"
TTV433	Not Included	1.575	0.315	0.197	0.374
TTV434	Not Included	1.969	0.315	0.197	0.394
TTV435	Not Included	2.756	0.453	0.236	0.512
TTV436	Not Included	3.150	0.512	0.315	0.610
TTV437	Included	3.150	0.512	0.315	0.610
TTV438	Included	3.937	0.630	0.394	0.768
TTV439	Not Included	3.397	0.630	0.394	0.768
TTV440	Not Included	4.724	0.630	0.433	0.787
TTV441	Included	5.906	0.787	0.512	0.984
TTV442	Not Included	5.906	0.787	0.512	0.984
TTV443	Included	7.874	0.906	0.630	1.122
TTV444	Not Included	7.874	0.906	0.630	1.122
TTV445	Not Included	10.236	1.102	0.748	1.457
TTV446	Included	10.236	1.102	0.748	1.457

# WELDING

Welding Wires .....	119	Flint Lighters.....	122
Cam Action Cable Connectors .....	119	Cable Protectors.....	123
Soapstones .....	120	Magnetic Holders.....	123
Welding Starter Kits .....	120	Scratch Brushes.....	123
Electrode Holders.....	121	Arc Gouging Torch .....	124
Grounding Clamps .....	121	Gouging Electrodes .....	124
Brass Gauges .....	122	Chipping Hammers.....	124
Tip Refacer .....	122	MIG Nozzle Reamers .....	124
Tip Drill Kit .....	122	MIG Pliers .....	124
Spiral Tip Cleaner.....	122	Cutting Tips.....	125, 126





## ER70S6 CARBON STEEL WELDING WIRES

- Highest combination of manganese and silicone deoxidizers
- Permits high current welding with CO<sub>2</sub> gas shielding
- Can also be applied with ArCO<sub>2</sub>
- Excellent wetting
- Good for out-of-position welding using short circuiting transfer
- Layer/level wound wire
- Certified by CWB to CSA class W48 for ER49S-6
- Certified by AWS to class A5.18 for ER70S6

Model No.	Diameter	Spool Weight	Spools Per Master Box
NT549	0.023" (0.6 mm)	2 lbs. (0.9 kg)	18
NT550	0.030" (0.8 mm)	2 lbs. (0.9 kg)	18
NT551	0.035" (0.9 mm)	2 lbs. (0.9 kg)	18
NT552	0.045" (1.14 mm)	2 lbs. (0.9 kg)	18
NT553	0.023" (0.6 mm)	11 lbs. (5 kg)	4
NT554	0.030" (0.8 mm)	11 lbs. (5 kg)	4
NT555	0.035" (0.9 mm)	11 lbs. (5 kg)	4
NT556	0.023" (0.6 mm)	33 lbs. (15 kg)	1
NT557	0.030" (0.8 mm)	33 lbs. (15 kg)	1
NT560	0.035" (0.9 mm)	44 lbs. (20 kg)	1
NT561	0.045" (1.14 mm)	44 lbs. (20 kg)	1

\*Sold per spool



## CAM ACTION CABLE CONNECTORS

- One model fits cable sizes 4 through 4/0
- Manufactured from heavy wall precision machined brass alloy
- Cable is held securely by large dome screw
- Brass body assembly slides easily into unique heavy-duty neoprene insulator with no external screws to avoid shock hazards
- Cam locking connectors are compatible with most common brands

Model No.	Description
NT664	Male/Female Connector Set
NT649	Male Half With Insulator
NT650	Female Half With Insulator



## ▶ SOAPSTONES

- White soapstone
- Sold in box quantity of 144

Model No.	Description	Length	Width	Height
NT225	Flat Soapstone	5	1/2	3/16
NT226	Round Soapstone	5	1/4	1/4



## ▶ SOAPSTONE HOLDERS

- Soapstone features highly visible white marking stick cut from natural stone which adheres to metal, stone, concrete and fabrics
- Soapstone holders feature a pocket clip
- Sold with one soapstone installed
- Replacement soapstones available

### ROUND HOLDER:

- Aluminum adjustable holder for 1/4" x 5" soapstone or chalk

### FLAT HOLDER:

- Steel adjustable holder for 1/2" x 5" flat soapstone or chalk

Model No.	Description
NT638	Round Holder
NT639	Flat Holder



## ▶ WELDING STARTER'S KIT

- 2" x 4-1/4" or 4-1/4" x 5-1/4" lightweight welding helmet, with shade 10 lens and ratchet headgear
- Cotton welder's beanie, one size fits all
- Welding gloves, split leather with full thermal lining
- Chipping hammer, cone and chisel head with spring steel handle
- MIG pliers, 8-way with nickel plated finish
- Safety glasses with adjustable temples

Model No.	Description
TTU300	Kit With 2" x 4-1/4" Helmet
TTU301	Kit With 4-1/2" x 5-1/4" Helmet



## ELECTRODE HOLDERS

- Grip the electrode closer to the end
- Allows you to use 20% more of the electrode than with standard tong holders
- Manufactured from copper alloy for maximum conductivity and strength
- Fibreglass insulators are designed to withstand intense heat and impact
- Will not burn, break or carbon char
- Electrode Capacity: 3/32" (2 mm) - 3/16" (5 mm)

Model No.	Amps	Description
NT629	400	Electrode Holder w/ Neck Ring
NT631	600	Electrode Holder w/ Neck Ring
NT630	400	Slimline – Bernard® Style Holder
NT818	-	Replacement Head For NT629 & NT630
TTV098	-	Replacement Head For NT631



NT629

NT631

NT630

## STANDARD GROUND CLAMPS

- Manufactured from nickel-plated steel with forged brass conductors
- Heavy-duty springs provide positive strength at jaws
- NT661 is ideal for farm welder and light shop work; current flows directly from lower jaw to welding cable
- AUW394 is ideal for portable gas drive welders; braided zinc coated copper strap carries current to both upper and lower jaws, fully insulated hinge and spring prevents arcing

Model No.	Amps
NT661	300
AUW394	500



NT661

## HEAVY-DUTY "C-STYLE" GROUND CLAMP

- C-type jaws are adjusted by screw lever
- Rubber insulated cable connector

Model No.	Amps
NT665	600

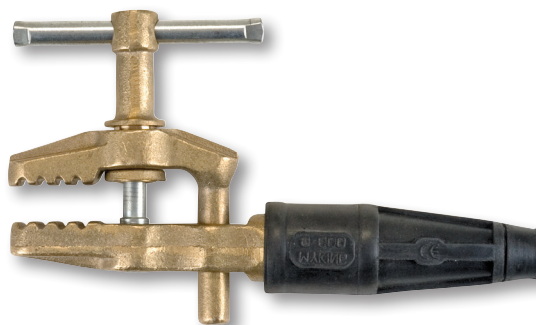

## HEAVY-DUTY GROUND CLAMPS

- Manufactured from heavy-duty nickel-plated steel with forged brass conductors and braided copper strap to carry current to upper jaw
- Heavy-duty spring provides positive contact at jaws
- Cable is easy to install with built-in cable connector and oval point screw
- Allen-type wrench included

Model No.	Amps
NT668	300
NT669	500



## BRASS GAUGES

- Brass casing
- Lexan™ cover lens
- 1/4" NPT inlet
- Dial type: Analogue
- Connection: Bottom Mount
- **NT618 & NT623** have red line indicators



NT618



NT616



Model No.	Dial Diameter"	Pressure Range (PSI)
NT616	2	100
NT618	2	30
NT619	2	400
NT620	2	4000
NT622	2-1/2	200
NT623	2-1/2	30
NT624	2-1/2	400
NT625	2-1/2	4000

## TIP-NIP TIP REFACER

- For easy, fast precision tip resurfacing
- Insert tip and give a few turns
- Pitted tip is resurfaced for new performance
- Extends tip life

Model No. NT820



## TIP DRILL KIT

- Cleans welding tips and a variety of other fuel orifices and injectors
- Includes 12 drills in sizes 52-74
- Promotes more effective fuel use and increases performance in welding, cutting and heating tips
- Drills store neatly in pipe vise handle

Model No. NT660



## SPIRAL TIP CLEANER

- Cleaning data on back of case
- Hardening steel file included in each case
- Standard or extra long King set
- Quality aluminum case



Model No.	Description
NT641	Standard Set - 12 Cleaners
TTV223	King Set - 13 Cleaners

## FLINT LIGHTERS

- Choice of single or three flint lighters
- Additional flints sold separately

Model No.	Description
NT642	Single Flint Lighter
NT663	Flints, 5 per Holder
TTU071	Three Flint Lighter
TTU072	Flints
TTU432	Single Flint Lighter, With 5 Flint Holder

NT642



TTU071



NT663



TTU072



## CABLE PROTECTOR

- Durable leather with Kevlar® sewn seams
- Lightweight to enhance flexibility and strength
- Metal snaps every 3"
- For TIG, MIG, plasma and lux-cored torch cable/hose assembly
- 4" W x 22' L



Model No. NP520

## PYTHONRAP™ CABLE COVER

- Nylon cover
- Full length zipper
- 4" W x 22' L



Model No. NT887

## ROD HOLDER

- Double leather bottom and metal swivel clip
- 5-ply Kevlar® stitched with rivet reinforcement
- Holds electrodes up to 15"

Model No. NP519

Rods not included



## MAGNETIC HOLDERS

- Multi-purpose holders for assembly and positioning
- Adheres to any metal object
- Ideal for welding, soldering, assembly, pipe installation



Model No.	Size	Dimensions L" x W" x H"	Strength lbs.
NT626	Medium	5 x 3-1/4 x 1/2	15
NT627	Large	6-1/4 x 4 x 3/4	25
NT628	X-Large	8 x 5 x 1	40

## INDUSTRIAL DUTY SCRATCH BRUSHES

- Wood handle
- Choice of carbon or stainless steel bristles

Model No.	Bristles	Brush Length"	Overall Length"	Trim Length"	Wire Rows
<b>LONG HANDLE BRUSHES</b>					
NT607	Carbon Steel	5-3/4	13-3/4	1	3 x 19
NT608	Carbon Steel	5-3/4	13-3/4	1	4 x 19
NT611	Stainless Steel	5-3/4	13-3/4	1	3 x 19
NT612	Stainless Steel	6	10-1/4	1	4 x 19
<b>SHOE HANDLE BRUSHES</b>					
NT609	Carbon Steel	5-1/4	10-1/2	1	3 x 16
NT610	Carbon Steel	5-1/4	10-1/2	1	4 x 16
NT613	Stainless Steel	5	10-1/2	1	3 x 16
NT614	Stainless Steel	5	10-1/4	1	4 x 16
<b>"TOOTHBRUSH" CLEANING BRUSH</b>					
NT615	Stainless Steel	1-1/2	7-3/4	1/2	3 x 7



NT607



NT609

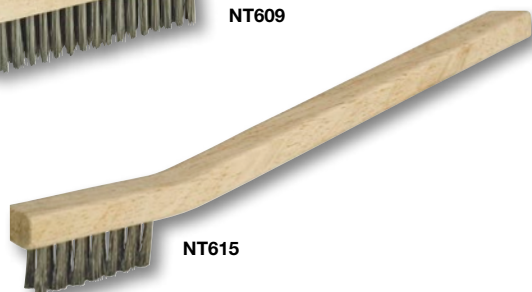

NT615

## AIR CARBON ARC GOUGING TORCH

- For gouging, cutting, beveling, piercing and flushing metal
- Economical air carbon arc cutting process
- Can be used on most metals
- Chemical changes are virtually nil, as the process is primarily physical

Model No.	Amps
NT667	800

### AIR REQUIREMENTS

Ordinary compressed air as supplied by a shop airline or compressor is suitable. Most applications require 80-100 PSI.

<b>Air</b>	
PSI:	80
kg/cm <sup>2</sup> :	5.6
CFM:	35
CMM:	0.076
<b>Compressor</b>	
Intermittent:	5 HP (3.73 kW)
Continuous:	7.5 HP (5.60 kW)



## AIR CARBON GOUGING ELECTRODES

- Consistent copper coating DCCC
- Used for gouging out defective welds and cutting non-ferrous metals
- Electrodes are 12" in length
- Sold per package

Model No.	Dia."	Qty/Pkg
NT632	5/32	100
NT633	3/16	50
NT634	1/4	50
NT635	5/16	50
NT636	3/8	50
NT637	1/2	50

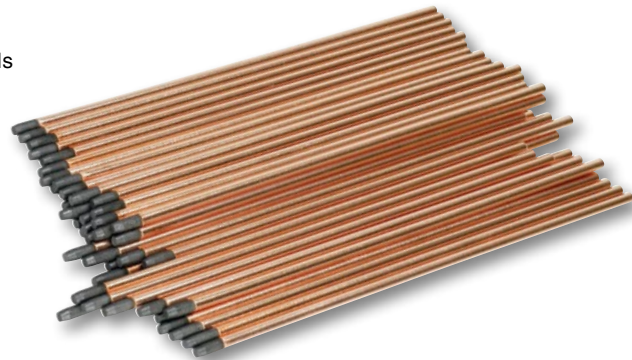

## CHIPPING HAMMER

- Cone and chisel head
- Spring steel handle
- Head length: 6-1/4"
- Overall length: 10-1/2"

Model No. NP532



## MIG NOZZLE REAMERS

- Cleans hot MIG nozzle on the torch
- Self adjusting to fit all size nozzles
- Expanding spring steel cleaner

Model No. TTU660



## MULTI-PURPOSE MIG PLIERS

- Eight-way pliers
- Nickel plated finish
- Ideally suited for removal of hot spatter from nozzle ends, as well as many other uses



Model No.	Description
NP537	Pliers
TYX128	Premium Pliers
NT666	Holster for Pliers

## CUTTING TIP CHART

Material Thickness	1/8	1/4	1/2	3/4	1	1-1/2	2	4	5	6	8	10	12
Recommended Tip Number / And Drill Size	00 / 68	0 / 60	1 / 56	1 / 56	2 / 54	2 / 54	3 / 52	3 / 49	4 / 44	6 / 38	6 / 31	7 / 28	8
Oxygen Pressure Setting lb/in <sup>2</sup> g	20-25	25-30	30-35	30-35	35-40	40-45	40-45	40-50	45-55	45-55	45-55	45-55	45-55
Acetylene Pressure Setting lb/in <sup>2</sup> g	3-5	3-5	3-5	3-5	3-7	3-7	5-10	5-10	6-12	7-13	8-14	10-15	10-15
Cutting in/min	27-30	26-29	20-24	17-21	14-18	13-17	12-15	8-11	7-9	6-8	5-6	4-5	3-4

### AIRCO® 144/ALC 802 STYLE CUTTING TIPS

- For general, hand or machine cutting
- Acetylene-oxygen
- Medium preheat
- Fits Airco® 3790, 4690, 4700, 4800, 5700, 5800, 1100, 3000, 9000 and 9500 style torches

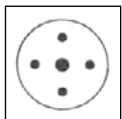

Model No.	Size
TTU465	00
TTU466	0
TTU467	1
TTU468	2
TTU469	3
TTU470	4

### AIRCO® 164/ALC 803 STYLE CUTTING TIPS

- For general, and cast iron or stainless steel cutting
- Acetylene-oxygen
- Very high preheat
- Fits Airco® 3790, 4690, 4700, 4800, 5700, 5800, 1100, 3000, 9000 and 9500 style torches

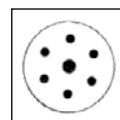

Model No.	Size
TTU471	00
TTU358	0
TTU359	1
TTU360	2
TTU361	3
TTU362	4
TTU472	5
TTU473	6
TTU474	7

### AIRCO® 261/ALC 829 STYLE CUTTING TIPS

- For general cutting, two-piece tip for hand cutting
- Propane or oxygen-natural gas
- High preheat
- Fits Airco® 2900, 3790, 4690, 4700, 4800, 5700, 5800, 1100, 3000, 9000 and 9500 style torches

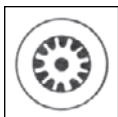

Model No.	Size
TTU475	0
TTU476	1
TTU477	2
TTU478	3
TTU479	4
TTU480	5

### PUROX® 4202/ESAB STYLE CUTTING TIPS

- For general cutting
- Acetylene-oxygen
- Medium preheat
- Fits CW-200, CW-202, CW-300, Type E torches, and C-205 machine torch

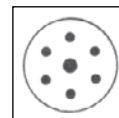

Model No.	Size
TTU481	3
TTU482	4
TTU483	5
TTU484	7
TTU485	9

### SMITH® MC12 STYLE CUTTING TIPS

- Hand cutting with oxy-acetylene
- Medium preheat
- Fits Smith® cutting assemblies MC505, MC509, AC305, and AC309

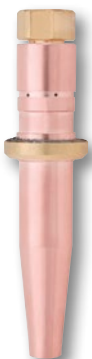
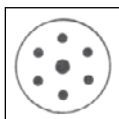

Model No.	Size
TTU530	1

### SMITH® SC12 STYLE CUTTING TIPS

- Hand or machine cutting with oxy-acetylene
- Medium preheat
- Fits Smith® cutting attachments SilverStar & MC40
- Fits Smith® cutting torches Tuf Tony & Silver Star
- Fits Smith® machine torches SC770, SC771, SC780A, SC781A, & SC782A

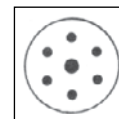

Model No.	Size
TTU531	1

## HARRIS® 6290 STYLE CUTTING TIPS

- For general hand cutting
- Acetylene-oxygen
- Medium preheat
- Fits Harris® 42-3, 62-3, 72, 72A, 73, 73A and 85 style torches

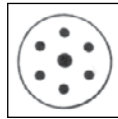

Model No.	Size
TTU458	000
TTU459	00
TTU349	0
TTU350	1
TTU351	2
TTU352	3
TTU460	4
TTU461	5
TTU462	6

## VICTOR® 1-101 STYLE CUTTING TIPS

- For general cutting
- Acetylene-oxygen
- Machine preheat for hand and machine cutting
- Fits 2460, CA 1060, ST, SST & 1400C machine torches

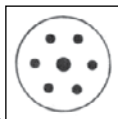

Model No.	Size
TTU441	000
TTU333	00
TTU334	0
TTU335	1
TTU336	2
TTU337	3
TTU338	4
TTU339	5
TTU442	6
TTU443	7
TTU444	8

## VICTOR® GPN STYLE CUTTING TIPS

- For general cutting
- Propane or oxygen-natural gas
- Medium preheat for hand and machine cutting
- Fits 2450, CA 1060, CAN 1060, ST, SST, STN, 1400C machine torches

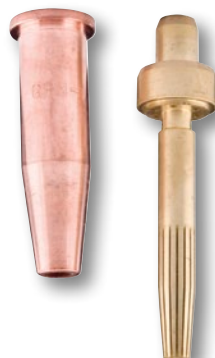

Model No.	Size
TTU452	00
TTU344	0
TTU345	1
TTU346	2
TTU347	3
TTU348	4
TTU453	5

## HARRIS® 6290-NX STYLE CUTTING TIPS

- For general hand cutting
- Propane or oxygen-natural gas
- Medium preheat
- Fits Harris® 42-3, 49AF, 49F, 62-3, 72, 73, 85, and 142 style torches



Model No.	Size
TTU463	000
TTU353	0
TTU354	1
TTU355	2
TTU356	3
TTU357	4
TTU464	5



## VICTOR® 3-101 STYLE CUTTING TIPS

- For general cutting
- Acetylene-oxygen
- Medium preheat hand cutting
- Fits CA 1260, CA 1350, C 1450, CA 2060, CST 800 & C 1400 torches

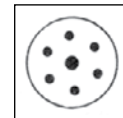

Model No.	Size
TTU448	000
TTU449	00
TTU340	0
TTU341	1
TTU342	2
TTU343	3
TTU450	4
TTU451	5



## VICTOR® 1-118 STYLE CUTTING TIPS

- For gouging
- Acetylene-oxygen
- Gouging, scarfing and deseaming
- Fits 2460, CA 1060, ST, SST & 1400C torches

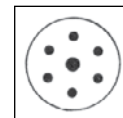

Model No.	Size
TTU445	2
TTU446	4
TTU447	6

## VICTOR® 3-GPN STYLE CUTTING TIPS

- For general cutting
- Propane or oxygen-natural gas
- Medium preheat series 3 tip
- Fits CA 1260, CA1350, C 1450, CA 2060, CST 800 & C 1400 torches



Model No.	Size
TTU454	0
TTU455	1
TTU456	2
TTU457	3





## -A-

<b>Abrasives</b>	
Files	20
Scratch Brushes	123
Surface Conditioning Discs	71
Surface Conditioning Pads	68
<b>Adhesives</b>	
Caulking Guns	19
Glue Guns	111
Glue Sticks	111
Tape	69
<b>Adjustable Wrenches</b>	16
<b>Air Products</b>	
Cut-Off Tools	75
Filters	78-79
Guns	80-81
Hose Reels	82
Hoses	82
In-Line Regulators	79
Lubricators	78
Quick Couplers	82
<b>Air Tools</b>	
Chippers	71
Drills	75
Grinders	74
Hammers	76
Sanders	71, 77
Scalers	71
Screwdrivers	71, 76
Wrenches	72-73
<b>Aluminum Foil Tape</b>	69
<b>Angle Grinders, Air</b>	74
<b>Automotive Tools</b>	45-46, 51

## -B-

<b>Bag Sealing Tape</b>	114
<b>Bags, Tool</b>	39
<b>Ball Pein Hammers,</b>	
Wood Handle	3-4
<b>Bars</b>	
Pry	18
Wrecking	18
<b>Batteries</b>	
AA Cell	104
AAA Cell	104
<b>Battery Tester</b>	104
<b>Belt Sanders, Air</b>	77
<b>Belts, Tool</b>	38
<b>Bench Vises</b>	53-54
<b>Bits, Drill</b>	19
<b>Blades, Packaging Knife</b>	113
<b>Blow Guns</b>	80-81
<b>Bolt Cutters</b>	18
<b>Booster Cables</b>	98
<b>Box Sealing Tape</b>	115
<b>Box Sealing</b>	
Tape Dispensers	115
<b>Boxes</b>	
Jobsite	39
Tool Storage	40
<b>Broadcast Spreaders</b>	92-95
<b>Brushes</b>	
Paint	66
Scratch	123
Snow	97

## -C-

<b>Cabinet Tip Screwdrivers</b>	11
---------------------------------	----

<b>Cable Connectors,</b>	
Welding	119
<b>Cable Protectors, Welding</b>	123
<b>Cable Ties</b>	113
<b>Cables, Booster</b>	98
<b>Calipers, Digital</b>	34
<b>Cans</b>	
Oil	64
Paint	67
<b>Carton Staplers</b>	111
<b>Carts, Tool</b>	41-43
<b>Cases, Small Parts</b>	39
<b>Caulking Guns</b>	19
<b>C-Clamps</b>	56
<b>Center Punches</b>	22-23
<b>Chests, Tool Storage</b>	42
<b>Chippers, Air</b>	71
<b>Chipping Hammers,</b>	
Welding	124
<b>Chisels</b>	
Cold	21, 23
Scaling	71
<b>Clamps</b>	
C-Clamps	56
Ground - Welding	9, 121
Hold-Down	55
Latch	55
Parallel	56
Straight Line	55
Toggle	55
<b>Claw Hammers</b>	4
<b>Cleaners, Welding Tip</b>	122
<b>Club Hammers</b>	2
<b>Cold Chisels</b>	21, 23
<b>Combination</b>	
<b>Wrenches</b>	14-15
<b>Connectors</b>	
Cable	119
Straight Blade	103
<b>Control Valves</b>	60
<b>Cord Reels,</b>	
Extension Cords	102
<b>Cords, Extension</b>	100-102
<b>Couplers, Quick</b>	82
<b>Cross-Point Screwdrivers</b>	11
<b>Cups, Measuring</b>	64
<b>Curved Claw Hammers</b>	3
<b>Cut-Off Tools, Air</b>	75
<b>Cutters, Bolt</b>	18
<b>Cutting Tips</b>	125-126
<b>Cutting Tools, Drill Bits</b>	19

## -D-

<b>Dead Blow Hammers</b>	3-5
<b>Diagonal Cutters</b>	6
<b>Die Grinders, Air</b>	74
<b>Discs, Surface Conditioning</b>	71
<b>Dispensers</b>	
Box Sealing Tape	115
Filament Tape	116
Stretch Wrap	114
<b>Dock Lights, Swing Arm</b>	107
<b>Dollies</b>	
Knee	43
Mechanic's	43
<b>Drain Spades</b>	88-91
<b>Drift Punches</b>	22-23
<b>Drill Bits, Jobber</b>	19
<b>Drills, Air</b>	75
<b>Drop Sheets</b>	67

<b>Duct Tape</b>	116
------------------	-----

## -E-

<b>Electrical Tape</b>	69
<b>Electrode/Rod Containers</b>	123
<b>Electrode Holders</b>	121
<b>Electrodes, Gouging</b>	124
<b>Extension Cords</b>	100-102

## -F-

<b>Filament Tape Dispensers</b>	116
<b>Files</b>	20
<b>Filter/Regulator/Lubricators</b>	78
<b>Filter/Regulators</b>	79
<b>Filters, Air</b>	78-79
<b>Fittings, Lubrication</b>	61-63
<b>Flashlights</b>	108
<b>Flat Files</b>	20
<b>Flat Tip Screwdrivers</b>	11
<b>Flint Lighters</b>	122
<b>Flints</b>	122
<b>Floodlights</b>	106
<b>Funnels, Clean</b>	64

## -G-

<b>Garden Hoses</b>	94
<b>Garden Spades</b>	89-91
<b>Gauges, Pressure</b>	122
<b>GFCI, Power Strips</b>	102-103
<b>Glue, Sticks</b>	111
<b>Glue Guns</b>	111
<b>Gouging Electrodes</b>	124
<b>Gouging Torches</b>	124
<b>Grease Control Valves</b>	60
<b>Grease Guns</b>	58-59
<b>Grease Pumps</b>	60
<b>Grinders</b>	
Angle - Air	74
Die - Air	74
<b>Ground Clamps, Welding</b>	9, 121
<b>Gummed Tape</b>	116
<b>Guns</b>	
Air	80-81
Caulking	19
Garden Hose	93
Glue	111
Grease	58-59

## -H-

<b>Hacksaws, Frames</b>	18
<b>Hammer Tackers</b>	111
<b>Hammers</b>	
Air	76
Ball Pein	3-4
Chipping	124
Claw	3-4
Club	2
Dead Blow	3-5
Mallets	3-4
Sledge	2
<b>Hand Lamps</b>	107-108
<b>Hand Stamps</b>	5
<b>Hand Tools</b>	
Automotive	45-46, 51
Bolt Cutters	18
Chisels	21, 23, 71
Clamps	55-56
Hammers	2-5
Hex Keys	13

<b>Knives</b>	112-113
Levels	36
Magnets	123
Mallets	3-4
Multi-Purpose	6
Pipe Tools	16-17
Pliers	6-10
Pry Bars	18
Punches	21-23
Ratchets	24-28
Saws	18
Screwdrivers	11-12
Sealing Spatula	68
Snips	19
Socket Sets	30-33
Sockets	6, 25-29
Technicians'	13, 45-50
Vises	53-54
Wrecking Bars	18
Wrenches	14-16, 24
<b>Headlights, Hard Hat</b>	109
<b>Hex Bit Sockets</b>	6
<b>Hex Keys</b>	13
<b>Hinges, Weld-On</b>	117
<b>Hold-Down Clamps</b>	55
<b>Holders, Electrode</b>	121
<b>Hose Reels</b>	82
<b>Hoses</b>	
Air	82
Garden	94
Lubricant	61

## -I-

<b>Impact Wrenches, Air</b>	72
<b>Impulse Sealers</b>	116
<b>In-Line Filters</b>	79
<b>In-Line Lubricators</b>	78
<b>In-Line Regulators</b>	79
<b>Instruments</b>	
Battery Testers	104
Calipers	34
Distance Measurers	34-35
Micrometers	34
Pressure Gauges	122

## -J-

<b>Jobsite Boxes</b>	39
----------------------	----

## -K-

<b>Keys, Hex</b>	13
<b>Knives</b>	
Packaging	112
Utility	112-113

## -L-

<b>Latch Clamps</b>	55
<b>Levels, Torpedo</b>	36
<b>Lighters, Flint</b>	122
<b>Lighting</b>	
Dock Lights	107
Flashlights	108
Floodlights	106
Hand Lamps	107-108
Headlights	109
String Lights	107
Task Lights	106
Telescopic Lights	106
<b>Lineman's Pliers</b>	6
<b>Locking Pliers</b>	8-9

### Lubricating Equipment

Control Valves .....	60
Fittings .....	61-63
Grease Guns .....	58-59
Grease Pumps .....	60
Hoses .....	61
Oil Cans .....	64
Lubricators, In-Line .....	78

### -M-

Magnets, Welding Squares ..	123
Mallets .....	3-4
Markers	
Scribes .....	23
Soapstone .....	120
Masking Tape .....	69
Material Handling	
Dollies .....	43
Measurement Devices	
Tape .....	35
Wheels .....	34
Measuring Cups .....	64
Measuring Tapes .....	35
Measuring Wheels .....	34
Mechanic's Dollies .....	43
Metal Snips .....	19
Micrometers, Digital .....	34
MIG Pliers .....	124
MIG Wire, Steel .....	119
Moving Supplies,	
Tie-Downs .....	114
Multi-Purpose Hand Tools .....	6

### -N-

Nozzle Reamers .....	124
Nozzles, Garden Hose .....	93

### -O-

Oil Cans .....	64
Orbital Sanders, Air .....	71, 77

### -P-

Packaging	
Cable Ties .....	113
Impulse Sealers .....	116
Knife Blades .....	113
Knives .....	112
Staplers .....	111
Stretch Wrap Dispensers ..	114
Tape .....	69, 114-116
Tape Dispensers .....	115-116
Tie-Downs .....	114
Pads, Surface Conditioning ..	68
Paint Brushes .....	66-67
Paint Roller Covers .....	67
Painting Supplies	
Brushes .....	66-67
Drop Sheets .....	67
Paint Cans (Empty) .....	67
Roller Covers .....	67
Roller Frames .....	67
Parallel Clamps .....	56
Phillips® Screwdrivers .....	11
Pin Punches .....	21, 23
Pipe Fittings, Lubrication ..	61-63
Pipe Tools, Wrenches .....	16-17
Pliers	
Cutting .....	6
Lineman's .....	6

Locking .....	8-9
MIG .....	124
Sets .....	7, 9-10
Tongue & Groove .....	6
Pouches, Tool .....	38-39, 124
Power Strips, GFCI .....	102-103
Pressure Gauges, Dry .....	122
Pry Bars, Multi-Purpose .....	18
Pumps, Grease .....	60
Punches	
Center .....	22-23
Drift .....	22-23
Pin .....	21, 23

### -Q-

Quick Couplers .....	82
----------------------	----

### -R-

Rakes .....	90-91
Ratchet Wrenches, Air .....	72-73
Ratcheting Wrenches .....	24
Ratchets	
1/2" Drive .....	24-28
1/4" Drive .....	24
3/8" Drive .....	26
Reamers, Nozzle .....	124
Reels	
Cord .....	102
Hose .....	82
Welding .....	82
Refacers, Welding Tip .....	122
Regulators, In-Line .....	79
Robertson® Screwdrivers ..	11
Rod/Electrode Containers ..	123
Roller Frames .....	67
Rolling Knee Dollies .....	43
Round Point Shovels .....	88-91

### -S-

Sanders	
Belt - Air .....	77
Orbital - Air .....	71, 77
Saws, Hacksaws .....	18
Scalers, Air .....	71
Scaling Chisels .....	71
Scoop Shovels .....	92
Scratch Brushes .....	123
Screwdrivers	
Air .....	71, 76
Cabinet Tip .....	11
Cross-Point / Phillips® ..	11
Flat Tip / Slot .....	11
Sets .....	12
Square / Robertson® .....	11
Scribes, Tungsten Carbide ..	23
Sealant Tape .....	69
Sealants, Teflon® Tape .....	69
Sealers, Impulse .....	116
Sealing Spatula .....	68
Sets	
Cold Chisel .....	21, 23
Files .....	20
Pliers .....	7-10
Screwdriver .....	12
Socket .....	30-33
Wrench .....	14-15
Sheets, Drop .....	67
Shop Sweepers .....	86

### Shovels

Round Point .....	88-91
Scoop .....	92
Snow .....	97-98
Square Point .....	88, 90
Side Cutting Pliers .....	6
Sledge Hammers,	
Non-Sparking .....	2
Slot Screwdrivers .....	11
Small Parts Cases .....	39
Snips, Compound .....	19
Snow Brushes .....	97
Snow Shovels .....	97-98
Soapstone .....	120
Socket Accessories .....	24-28
Socket Sets .....	30-33
Sockets	
Deep .....	25-29
Hex Bit .....	6
Spark Plug .....	28
Standard .....	25-29
Spades	
Drain .....	88-91
Garden .....	89-91
Spark Plug Socket .....	28
Spatula, Sealing .....	68
Square Point Shovels .....	88, 90
Square Screwdrivers .....	11
Squares, Welding .....	123
Stamps, Hand .....	5
Staplers, Packaging .....	111
Staples, Office Staplers .....	111
Storage	
Jobsite Boxes .....	39
Small Parts Cases .....	39
Tool Bags .....	39
Tool Belts .....	38
Tool Boxes .....	40
Tool Carts .....	41-43
Tool Chests .....	42
Tool Pouches .....	38-39, 124
Straight Blade Connectors ..	103
Straight Line Clamps .....	55
Stretch Wrap Dispensers ..	114
String Lights .....	107
Surface Conditioning Discs ..	71
Surface Conditioning Pads ..	68
Surge Protectors .....	103
Sweepers .....	86

### -T-

### Tape

Aluminum Foil .....	69
Bag Sealing .....	114
Box Sealing .....	115
Duct .....	116
Electrical .....	69
Gummed .....	116
Masking .....	69
Measuring .....	35
Teflon® .....	69
Tape Dispensers	
Box Sealing Tape .....	115
Filament Tape .....	116
Tarpaulins .....	95
Task Lights .....	106
Technicians' Tools .....	13, 45-50
Teflon® Tape .....	69
Telescopic Lights .....	106
Testers, Battery .....	104

Tie-Downs .....	114
Ties, Cable .....	113
Tip Cleaners .....	122
Tip Refacers .....	122
Tips, Cutting .....	125-126
Toggle Clamps .....	55
Tongue & Groove Pliers .....	6
Tool Kit, Welder's .....	120
Tool Storage	
Bags .....	39
Belts .....	38
Boxes .....	40
Carts .....	41-43
Chests .....	42
Jobsite Boxes .....	39
Pouches .....	38-39, 124
Torches, Gouging .....	124
Torpedo Levels .....	36

### -U-

Utility Knives .....	112-113
----------------------	---------

### -V-

Vacuums	
Accessories .....	84-85
Wet / Dry .....	84-85
Vises, Bench .....	53-54

### -W-

Welder's Tool Kit .....	120
Welding Equipment & Supplies	
Cable Protectors .....	123
Chipping Hammers .....	124
Connectors .....	119
Cutting Tips .....	125-126
Electrode Holders .....	121
Flint & Flint Lighters .....	122
Gouging Electrodes .....	124
Gouging Torches .....	124
Ground Clamps .....	9, 121
MIG Pliers .....	124
MIG Wire .....	119
Nozzle Reamers .....	124
Reels .....	82
Rod/Electrode Containers ..	123
Tip Cleaners .....	122
Tip Refacers .....	122
Weld-On Hinges .....	117
Wheels, Measuring .....	34
Wire, MIG .....	119
Work Lights .....	106-108
Wrecking Bars .....	18
Wrenches	
Adjustable .....	16
Combination .....	14-15
Impact - Air .....	72
Pipe .....	16-17
Ratchet - Air .....	72-73
Ratcheting .....	24

The warranty and return policy stated and described below pertain to all products carrying the **Aurora Tools®** trademark. This warranty supersedes any and all manufacturer's warranties, written or implied. Our sole liability is limited to the repair or replacement of any product proven to be defective in material and/or workmanship and for which a warranty claim is made during the applicable warranty period. No claims for damages of any type will be allowed. All products are sold on this basis. Defective warranted products will be repaired or replaced at our sole discretion at no cost with a new or reconditioned product. This Warranty only applies when the product is used for the purpose for which it was originally designed, under normal operating conditions. This Warranty does not apply to products which have been abused, misused, modified or have been repaired by someone other than us. Discontinued warranted products will be replaced with products that are similar and available, or we will issue an appropriate credit. The specific warranty coverage for each product is as set out below. **Aurora Tools®** are only sold on a wholesale basis and accordingly, warranties only apply to purchasers for resale or for use in their business.

### **One-Year Limited Warranty** (Normal wear & tear expected) Applies to the following lines:

- Air Tools & Accessories
- Bench Vises
- Clamps (bent or broken handles void warranty)
- Extension Cords
- Glue Guns
- Hand Pads
- Hex Key Sets
- Hose Reels (hose upon our inspection)
- Landscaping Tools
- Lubricating Equipment
- Multi-Tools
- Precision Measuring Tools
- Staple Guns
- Steel Stamps
- Utility Knives
- Vacuums
- Tool Boxes

When presented to us within one (1) year from the invoice date of the original purchase, we will repair the defective product or will replace it, at our discretion.

### **Lifetime Warranty** (Normal wear & tear expected) Applies to the following lines:

- Adjustable Wrenches (Snipe or hammer marks void warranty)
- Bolt Cutters (excluding jaws)
- Combination Wrenches (snipe or hammer marks void warranty)
- Hammers (head only)
- Indestructible Hammers
- Pliers
- Punches & Chisels
- Pipe Wrenches (excluding jaws)
- Ratchet Bodies (snipe or hammer marks void warranty – Bent or broken handles void warranty)
- Screwdrivers (Hammer marks or bent shafts void warranty)
- Sockets & Accessories

This warranty does not cover products that are damaged through misuse, abuse, overloading, mishandling, accident, modification, neglect, or exposure to environmental factors. The only products expressly warranted for use in vehicles are the TEP500 and TEP501 provided they are mounted correctly in the vehicle with the provided rubber feet. All other claims for boxes used in a vehicle may be rejected. Ultraviolet rays and certain chemicals may also have an adverse effect upon paint finishes. Additives and UV inhibitors are included in the paint mix, but we cannot fully warrant against fading or blemish if exposed to the above conditions.

### **Return Policy**

Please return the COMPLETE tool, freight prepaid, to the **Aurora Tools®** Distributor where you purchased the product. If you have any questions, please contact your authorized **Aurora Tools®** Distributor (proof of purchase is required). This Warranty shall be governed by and interpreted in accordance with the laws of Quebec and the laws of Canada applicable therein.

# Contact us Today

Phone: 1-866-457-1161

E-mail: [info@aurora-tools.com](mailto:info@aurora-tools.com)



CATALOGUE A0923

